

# JVC

## DIGITAL VIDEO CAMERA

# GR-DVL920

Please visit our Homepage on the World Wide Web and answer our Consumer Survey (in English only):

<http://www.jvc-victor.co.jp/english/index-e.html>

For Accessories:

<http://www.jvc-victor.co.jp/english/accessory/>

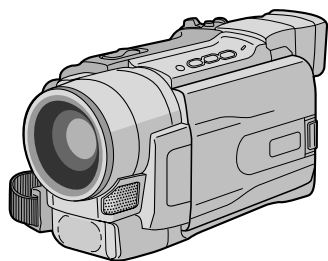

Mini DV NTSC  
DSC  
DIGITAL  
STILL CAMERA

## INSTRUCTIONS

ENGLISH

### CONTENTS

<b>AUTOMATIC DEMONSTRATION</b>	<b>6</b>
<b>GETTING STARTED</b>	<b>7 - 14</b>
<b>TAPE RECORDING &amp; PLAYBACK</b>	<b>15 - 24</b>
TAPE RECORDING .....	16 - 20
TAPE PLAYBACK .....	21 - 24
<b>MEMORY CARD RECORDING &amp; PLAYBACK</b>	<b>25 - 36</b>
MEMORY CARD RECORDING .....	26 - 27
MEMORY CARD PLAYBACK .....	28 - 29
ADVANCED FEATURES .....	30 - 36
<b>ADVANCED FEATURES</b>	<b>37 - 66</b>
FOR RECORDING .....	38 - 45
USING MENUS FOR DETAILED ADJUSTMENT .....	46 - 51
DUBBING .....	52 - 53
USING THE REMOTE CONTROL UNIT ...	54 - 64
SYSTEM CONNECTIONS .....	65 - 66
<b>REFERENCES</b>	<b>67 - Back Cover</b>
DETAILS .....	68
TROUBLESHOOTING .....	69 - 73
USER MAINTENANCE .....	74
CAUTIONS .....	75 - 77
SPECIFICATIONS .....	78 - 79
INDEX .....	80 - 86
TERMS .....	87 - Back Cover

#### For Customer Use:

Enter below the Model No. and Serial No. which is located on the bottom of the camcorder. Retain this information for future reference.

Model No. \_\_\_\_\_

Serial No. \_\_\_\_\_

LYT1017-001A

EN

**Dear Customer,**

Thank you for purchasing this digital video camera. Before use, please read the safety information and precautions contained in the following pages to ensure safe use of this product.

**Using This Instruction Manual**

- All major sections and subsections are listed in the Table Of Contents on the cover page.
- Notes appear after most subsections. Be sure to read these as well.
- Basic and advanced features/operation are separated for easier reference.

**It is recommended that you . . .**

- ..... refer to the Index (☞ pgs. 80 – 86) and familiarize yourself with button locations, etc. before use.
- ..... read thoroughly the Safety Precautions and Safety Instructions that follow. They contain extremely important information regarding the safe use of this product.

You are recommended to carefully read the cautions on pages 75 through 77 before use.

**SAFETY PRECAUTIONS**

**CAUTION**  
RISK OF ELECTRIC SHOCK  
DO NOT OPEN



**CAUTION:** TO REDUCE THE RISK OF ELECTRIC SHOCK,  
DO NOT REMOVE COVER (OR BACK).  
NO USER-SERVICEABLE PARTS INSIDE.  
REFER SERVICING TO QUALIFIED SERVICE PERSONNEL.



The lightning flash with arrowhead symbol, within an equilateral triangle, is intended to alert the user to the presence of uninsulated "dangerous voltage" within the product's enclosure that may be of sufficient magnitude to constitute a risk of electric shock to persons.



The exclamation point within an equilateral triangle is intended to alert the user to the presence of important operating and maintenance (servicing) instructions in the literature accompanying the appliance.

**WARNING:**

**TO REDUCE THE RISK OF FIRE  
OR ELECTRIC SHOCK, DO NOT  
EXPOSE THIS APPARATUS TO  
RAIN OR MOISTURE.**

**NOTES:**

- The rating plate (serial number plate) and safety caution are on the bottom and/or the back of the main unit.
- The rating information and safety caution of the AC Adapter are on its upper and lower sides.

**CAUTIONS:**

- This camcorder is designed to be used with NTSC-type color television signals. It cannot be used for playback with a television of a different standard. However, live recording and LCD monitor/viewfinder playback are possible anywhere.
- Use the JVC BN-V408U/V416U/V428U battery packs and, to recharge them or to supply power to the camcorder from an AC outlet, use the provided multi-voltage AC Adapter. (An appropriate conversion adapter may be necessary to accommodate different designs of AC outlets in different countries.)

When the equipment is installed in a cabinet or on a shelf, make sure that it has sufficient space on all sides to allow for ventilation (10 cm (3-15/16") or more on both sides, on top and at the rear).

Do not block the ventilation holes.

(If the ventilation holes are blocked by a newspaper, or cloth etc. the heat may not be able to get out.)

No naked flame sources, such as lighted candles, should be placed on the apparatus.

When discarding batteries, environmental problems must be considered and the local rules or laws governing the disposal of these batteries must be followed strictly.

The apparatus shall not be exposed to dripping or splashing.

Do not use this equipment in a bathroom or places with water.

Also do not place any containers filled with water or liquids (such as cosmetics or medicines, flower vases, potted plants, cups etc.) on top of this unit.

(If water or liquid is allowed to enter this equipment, fire or electric shock may be caused.)

## IMPORTANT PRODUCT SAFETY INSTRUCTIONS

- (1) Read these instructions.
- (2) Keep these instructions.
- (3) Heed all warnings.
- (4) Follow all instructions.
- (5) Do not use this apparatus near water.
- (6) Clean only with dry cloth.
- (7) Do not block any ventilation openings. Install in accordance with the manufacturer's instructions.
- (8) Do not install near any heat sources such as radiators, heat registers, stoves, or other apparatus (including amplifiers) that produce heat.
- (9) Only use attachments/accessories specified by the manufacturer.
- (10) Use only with the cart, stand, tripod, bracket, or table specified by the manufacturer, or sold with the apparatus. When a cart is used, use caution when moving the cart/apparatus combination to avoid injury from tip-over.
- (11) Unplug this apparatus during lightning storms or when unused for long periods of time.
- (12) Refer all servicing to qualified service personnel. Servicing is required when the apparatus has been damaged in any way, such as power-supply cord or plug is damaged, liquid has been spilled or objects have fallen into the apparatus, the apparatus has been exposed to rain or moisture, does not operate normally, or has been dropped.



## SAFETY PRECAUTIONS

Do not point the lens or the viewfinder directly into the sun. This can cause eye injuries, as well as lead to the malfunctioning of internal circuitry. There is also a risk of fire or electric shock.

### CAUTION!

The following notes concern possible physical damage to the camcorder and to the user.

When carrying, be sure to always securely attach and use the provided shoulder strap. Carrying or holding the camcorder by the viewfinder and/or the LCD monitor can result in dropping the unit, or in a malfunction.

Take care not to get your finger caught in the cassette holder cover. Do not let children operate the camcorder, as they are particularly susceptible to this type of injury.

Do not use a tripod on unsteady or unlevel surfaces. It could tip over, causing serious damage to the camcorder.

### CAUTION!

Connecting cables (Audio/Video, S-Video, etc.) to the camcorder and leaving the unit on top of the TV is not recommended, as tripping on the cables will cause the camcorder to fall, resulting in damage.



- This camcorder is designed exclusively for the digital video cassette, SD Memory Card and MultiMediaCard. Only cassettes marked “Mini DV” and memory cards\* marked “SD” or “MultiMediaCard” can be used with this unit.

### Before recording an important scene . . .

- .... make sure you only use cassettes with the Mini DV mark <sup>Mini</sup> DV .
- .... make sure you only use memory cards with the mark **SD** or *MultiMediaCard* .
- .... remember that this camcorder is not compatible with other digital video formats.
- .... remember that this camcorder is intended for private consumer use only. Any commercial use without proper permission is prohibited. (Even if you record an event such as a show, performance or exhibition for personal enjoyment, it is strongly recommended that you obtain permission beforehand.)

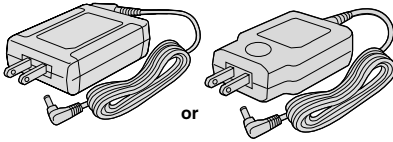

**AC Adapter AP-V10U,  
AP-V11U or AP-V12U**

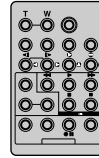

**Remote Control  
Unit RM-V717U**

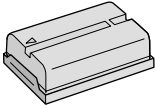

**Battery Pack  
BN-V408U**



**Lens Cap  
( pg. 6 for attachment)**

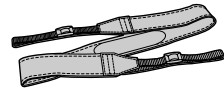

**Shoulder Strap**

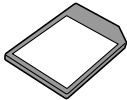

**Memory Card 16 MB  
(Already inserted in  
the camcorder)**



**AAA (R03) Battery x 2  
(for remote control unit)**

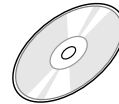

**CD-ROM**



**Audio/Video Cable  
(ø3.5 mini-plug to RCA plug)**

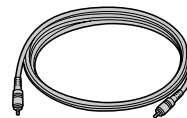

**Editing Cable**

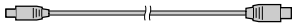

**USB Cable**



**Lens hood  
(Already attached to the  
camcorder)**

**NOTE:**

In order to maintain optimum performance of the camcorder, provided cables may be equipped with one or more core filter. If a cable has only one core filter, the end that is closest to the filter should be connected to the camcorder.

## AUTOMATIC DEMONSTRATION

Automatic Demonstration takes place when “**DEMO MODE**” is set to “**ON**” (factory-preset).

- Automatic Demonstration starts when there is no operation for about 3 minutes after the Power Switch is set to “**AUTO**” or “**MANUAL**” and no cassette is in the camcorder.
- Performing any operation during the demonstration stops the demonstration temporarily. If no operation is performed for more than 3 minutes after that, the demonstration will resume.
- “**DEMO MODE**” remains “**ON**” even if the camcorder power is turned off.
- To cancel Automatic Demonstration:

1. Set the Power Switch to “**MANUAL**” while pressing down the Lock Button located on the switch and press the **MENU/BRIGHT** wheel in. The Menu Screen appears.
2. Rotate the **MENU/BRIGHT** wheel to select “**SYSTEM**” and press it. The SYSTEM Menu appears.
3. Rotate the **MENU/BRIGHT** wheel to select “**DEMO MODE**” and press it. The Sub Menu appears.
4. Rotate the **MENU/BRIGHT** wheel to select “**OFF**” and press it.
5. Rotate the **MENU/BRIGHT** wheel to select “**RETURN**”, and press it twice. The normal screen appears.

MENU/BRIGHT Wheel

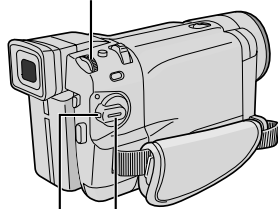

Power Switch

Lock Button

Sub Menu

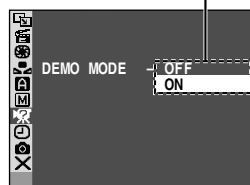

### NOTE:

If you do not detach the Lens Cap, you cannot see the actual changes of the Automatic Demonstration activated on the LCD monitor or viewfinder.

### How To Attach The Lens Cap

To protect the lens, attach the provided lens cap to the camcorder as shown in the illustration.

### NOTE:

To confirm the lens cap is on correctly make sure the cap is flush to the camera.

1

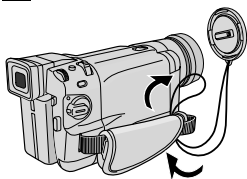

2

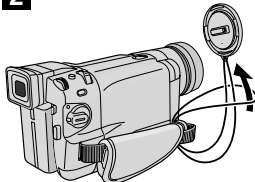

3

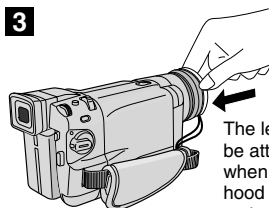

The lens cap can be attached only when the lens hood is attached to the camcorder.

**GETTING STARTED****CONTENTS**

<b>Power .....</b>	<b>8 – 9</b>
<b>Grip Adjustment .....</b>	<b>10</b>
<b>Viewfinder Adjustment .....</b>	<b>10</b>
<b>Shoulder Strap Attachment .....</b>	<b>10</b>
<b>Tripod Mounting .....</b>	<b>10</b>
<b>Date/Time Settings .....</b>	<b>11</b>
<b>Loading/Unloading A Cassette .....</b>	<b>12</b>
<b>Recording Mode Setting .....</b>	<b>13</b>
<b>Loading A Memory Card .....</b>	<b>14</b>
<b>Picture Quality/Image Size Setting .....</b>	<b>14</b>

## BATT. RELEASE Button

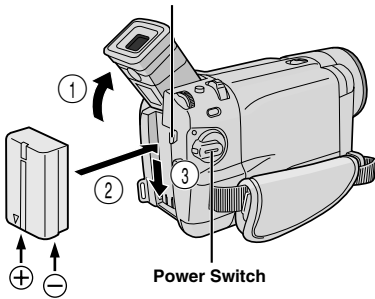

## Power Switch

## CHARGE Lamp

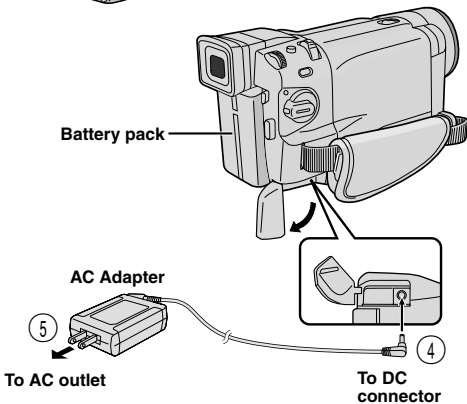
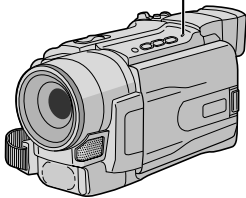

To AC outlet

To DC connector

## Power

This camcorder's 2-way power supply system lets you choose the most appropriate source of power. Do not use provided power supply units with other equipment.

## CHARGING THE BATTERY PACK

- 1** Tilt the viewfinder upward ①. With the arrow on the battery pack pointing downward, push the battery pack slightly against the battery pack mount ②, then slide down the battery pack until it locks in place ③.
- 2** Set the Power Switch to "OFF". Connect the AC Adapter to the camcorder ④.
- 3** Plug the AC Adapter into an AC outlet ⑤. The CHARGE lamp on the camcorder blinks to indicate charging has started.
- 4** When the CHARGE lamp stops blinking but stays lit, charging is finished. Unplug the AC Adapter from the AC outlet. Disconnect the AC Adapter from the camcorder.

## To Detach The Battery Pack . . .

..... Press **BATT. RELEASE** and pull out the battery pack.

## NOTES:

- If the protective cap is attached to the battery pack, remove it first.
- During charging, the camcorder cannot be operated.
- Charging is not possible if the wrong type of battery is used.
- When charging the battery pack for the first time or after a long storage period, the CHARGE lamp may not light. In this case, remove the battery pack from the camcorder, then try charging again.
- If the battery operation time remains extremely short even after having been fully charged, the battery is worn out and needs to be replaced. Please purchase a new one.
- Using the optional AA-V40U AC Power Adapter/Charger, you can charge the BN-V408U/V416U/V428U battery pack without the camcorder. However, it cannot be used as an AC adapter.

Battery pack	Charging time
BN-V408U	approx. 1 hr. 30 min.
BN-V416U (optional)	approx. 3 hrs.
BN-V428U (optional)	approx. 5 hrs.



**ATTENTION**

Before detaching the power source, make sure that the camcorder's power is turned off. Failure to do so can result in a camcorder malfunction.

**NOTES:**

- Recording time is reduced significantly under the following conditions:
  - Zoom or Record-Standby mode is engaged repeatedly.
  - The LCD monitor is used repeatedly.
  - The playback mode is engaged repeatedly.
- Before extended use, it is recommended that you prepare enough battery packs to cover 3 times the planned shooting time.

**USING THE BATTERY PACK**

Perform step 1 of "CHARGING THE BATTERY PACK" (☞ pg. 8).

**Approximate recording time**

Battery pack	LCD monitor on	Viewfinder on
BN-V408U	55 min. (35 min.)	1 hr. 10 min. (45 min.)
BN-V416U (optional)	1 hr. 55min. (1 hr. 15 min.)	2 hrs. 25 min. (1 hr. 30 min.)
BN-V428U (optional)	3 hrs. 25 min. (2 hrs. 15 min.)	4 hrs. 20 min. (2 hrs. 40 min.)
BN-V840U (optional)	4 hrs. 25 min. (2 hrs. 55 min.)	5 hrs. 40 min. (3 hrs. 30 min.)
BN-V856U (optional)	6 hrs. 40 min. (4 hrs. 15 min.)	8 hrs. 30 min. (5 hrs. 5 min.)

( ) : when the video light is on

**INFORMATION**

The extended-use battery pack kit is a set composed of a battery pack and AC Power Adapter/Charger:

VU-V840 KIT: BN-V840U battery pack & AA-V15U AC Power Adapter/Charger

VU-V856 KIT: BN-V856U battery pack & AA-V80U AC Power Adapter/Charger

Read the kit's instruction manual before using.

Also, by using the optional JVC VC-VBN856U DC Cord, it will be possible to connect BN-V840U or BN-V856U battery packs to the camcorder and supply power directly to the camcorder.

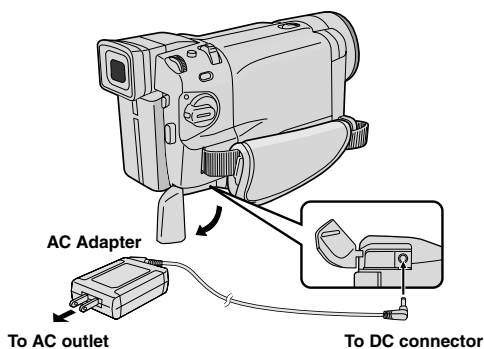
**USING AC POWER**

Use the AC Adapter (connect as shown in the illustration).

**NOTES:**

- The provided AC Adapter features automatic voltage selection in the AC range from 110 V to 240 V.
- For other notes, ☞ pg. 68.

**About Batteries**

**DANGER!** Do not attempt to take the batteries apart, or expose them to flame or excessive heat, as it may cause a fire or explosion.

**WARNING!** Do not allow the battery or its terminals to come in contact with metals, as this can result in a short circuit and possibly start a fire.

**The Benefits Of Lithium-Ion Batteries**

Lithium-ion battery packs are small but have a large power capacity. However, when one is exposed to cold temperatures (below 10°C/50°F), its usage time becomes shorter and it may cease to function. If this happens, place the battery pack in your pocket or other warm, protected place for a short time, then re-attach it to the camcorder. As long as the battery pack itself is not cold, it should not affect performance.

(If you're using a heating pad, make sure the battery pack does not come in direct contact with it.)

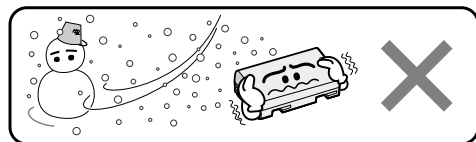

Lithium-ion is vulnerable in colder temperatures.

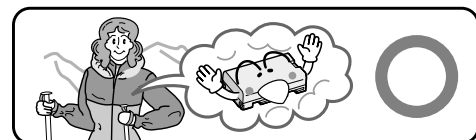

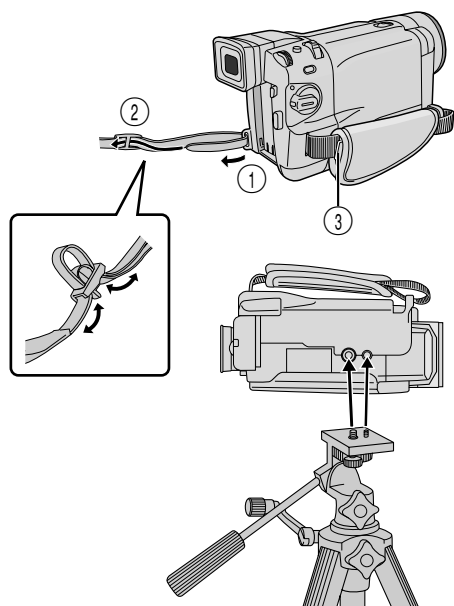
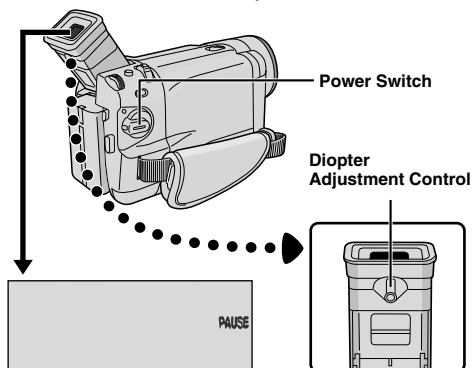
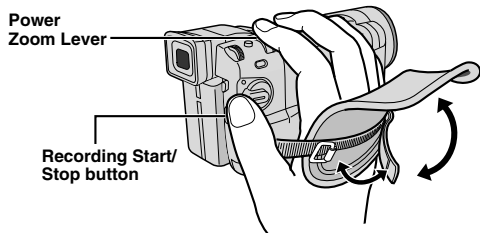

## Grip Adjustment

- 1** Separate the Velcro strip.
- 2** Pass your right hand through the loop and grasp the grip.
- 3** Adjust your thumb and fingers through the grip, to easily operate the Recording Start/Stop button and Power Switch and Power Zoom Lever. Be sure to fasten the Velcro strip to your preference.

## Viewfinder Adjustment

- 1** Set the Power Switch to "AUTO" or "MANUAL" while pressing down the Lock Button located on the switch.
- 2** Turn the Diopter Adjustment Control until the indications in the viewfinder are clearly focused.

## Shoulder Strap Attachment

- 1** Make sure the battery pack is removed. Following the illustration, thread the strap through the eyelet ①, then fold it back and thread it through the buckle ②. Repeat the procedure to attach the other end of the strap to the other eyelet ③ located under the Grip Strap. Confirm the strap is not twisted.

## Tripod Mounting

### CAUTION

When attaching the camcorder to a tripod, extend its legs to stabilize the camcorder. It is not advised to use small sized tripods. This may cause damage to the unit by falling over.

- 1** To attach the camcorder to a tripod, align the direction stud and screw to the mounting socket and stud hole on the camcorder. Then tighten the screw clockwise. Some tripods are not equipped with studs.

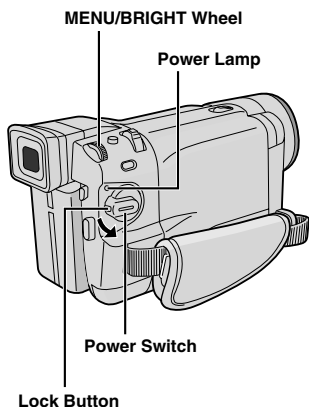

## Display

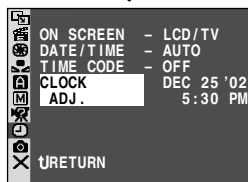
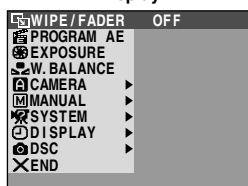

## DISPLAY Menu

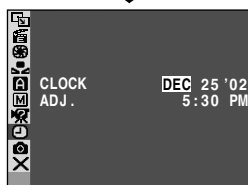

## Date/Time Settings

The date/time is recorded onto the tape at all times, but its display can be turned on or off during playback (▶▶ pg. 50, 51).

- 1** Set the Power Switch to "**MANUAL**" while pressing down the Lock Button located on the switch. The power lamp lights and the camcorder is turned on.
- 2** Press the **MENU/BRIGHT** wheel in to access the Menu Screen.
- 3** Rotate the **MENU/BRIGHT** wheel to select "**DISPLAY**". Press it and the DISPLAY Menu appears.
- 4** Rotate the **MENU/BRIGHT** wheel to select "**CLOCK ADJ.**". Press it and "month" is highlighted. Rotate the **MENU/BRIGHT** wheel to input the month. Press it. Repeat to input the day, year, hour and minute. Rotate the **MENU/BRIGHT** wheel to select "**RETURN**", and press it twice. The Menu Screen closes.

**NOTE:**

Even if you select "CLOCK ADJ.", if the parameter is not highlighted the camcorder's internal clock continues to operate. Once you move the highlight bar to the first date/time parameter (month), the clock stops. When you finish setting the minute and press the **MENU/BRIGHT** wheel in, the date and time begin operation from the date and time you just set.

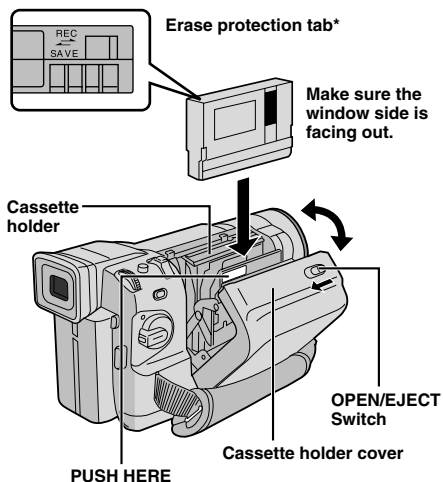

### \* To Protect Valuable Recordings . . .

... slide the erase protection tab on the back of the tape in the direction of "SAVE". This prevents the tape from being recorded over. To record on this tape, slide the tab back to "REC" before loading it.

Be sure to press only the section labeled "PUSH HERE" to close the cassette holder; touching other parts may cause your finger to get caught in the cassette holder, resulting in injury or product damage.

### NOTES:

- It takes a few seconds for the cassette holder to open. Do not apply force.
- If you wait a few seconds and the cassette holder does not open, close the cassette holder cover and try again. If the cassette holder still does not open, turn the camcorder off then on again.
- If the tape does not load properly, open the cassette holder cover fully and remove the cassette. A few minutes later, insert it again.
- When the camcorder is suddenly moved from a cold place to a warm environment, wait a short time before opening the cassette holder cover.
- Closing the cassette holder cover before the cassette holder comes out may cause damage to the camcorder.
- Even when the camcorder is switched off, a cassette can be loaded or unloaded. After the cassette holder is closed with the camcorder switched off, however, it may not recede. It is recommended to turn the power on before loading or unloading.
- When resuming recording, once you open the cassette holder cover a blank portion will be recorded on the tape or a previously recorded scene will be erased (recorded over) regardless of whether the cassette holder came out or not. See page 20 for information about recording from the middle of a tape.
- Loosen the Grip Strap if it appears to interfere with the cassette holder cover operation (ⓘ pg. 10).

## Loading/Unloading A Cassette

The camcorder needs to be powered up to load or eject a cassette.

**1** Slide and hold **OPEN/EJECT** in the direction of the arrow then pull the cassette holder cover open until it locks. The cassette holder opens automatically.

- Do not touch internal components.

**2** Insert or remove a tape and press "PUSH HERE" to close the cassette holder.

- Once the cassette holder is closed, it recedes automatically. Wait until it recedes completely before closing the cassette holder cover.
- When the battery's charge is low, you may not be able to close the cassette holder cover. Do not apply force. Replace the battery with a fully charged one before continuing.

**3** Close the cassette holder cover firmly until it locks into place.

### Approximate recording time

Tape	Recording mode	
	SP	LP
30 min.	30 min.	45 min.
60 min.	60 min.	90 min.
80 min.	80 min.	120 min.

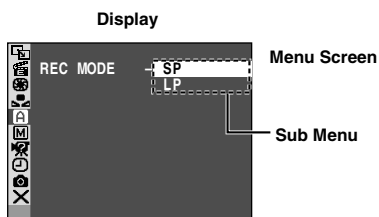
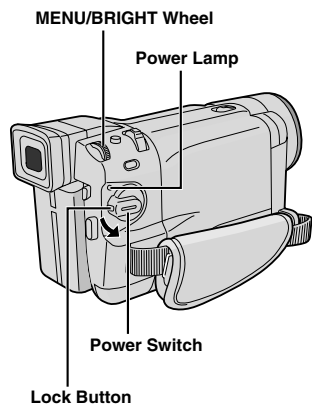

## Recording Mode Setting

Set the tape recording mode depending on your preference.

**1** Set the Power Switch to “**MANUAL**” while pressing down the Lock Button located on the switch. The power lamp lights and the camcorder is turned on.

**2** Press the **MENU/BRIGHT** wheel in. The Menu Screen appears.

**3** Rotate the **MENU/BRIGHT** wheel to select “**▲ CAMERA**” and press it. The CAMERA Menu appears.

**4** Rotate the **MENU/BRIGHT** wheel to select “**REC MODE**” and press it. The Sub Menu appears. Select “**SP**” or “**LP**” by rotating the **MENU/BRIGHT** wheel and press it. Rotate the **MENU/BRIGHT** wheel to select “**RETURN**”, and press it twice. The Menu Screen closes.

- Audio Dubbing (pg. 63) and Insert Editing (pg. 64) are possible on tapes recorded in the SP mode.
- “LP” (Long Play) is more economical, providing 1.5 times the recording time.

### NOTES:

- If the recording mode is switched during recording, the playback picture will be blurred at the switching point.
- It is recommended that tapes recorded in the LP mode on this camcorder be played back on this camcorder.
- During playback of a tape recorded on another camcorder, blocks of noise may appear or there may be momentary pauses in the sound.

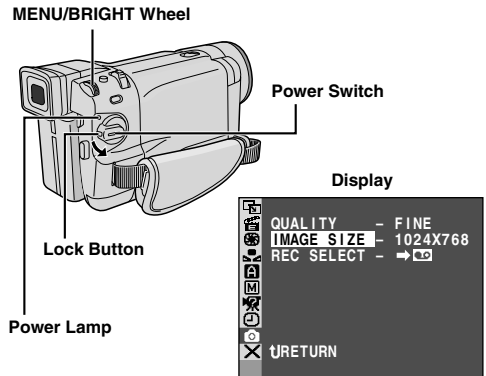
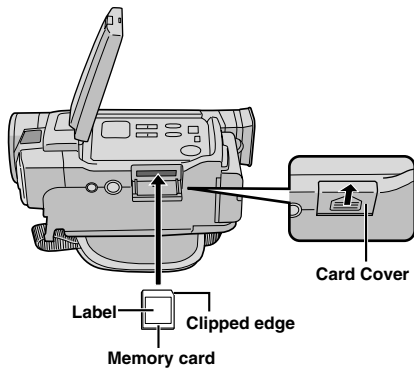

## Loading A Memory Card

The provided memory card is already inserted in the camcorder when you receive the camcorder.

- 1** Make sure the camcorder's power is off.
- 2** Press **PUSH OPEN** and open the LCD monitor, then open the card cover (**MEMORY CARD**).
- 3** Insert the memory card clipped edge first.
  - Do not touch the terminal on the reverse side of the label.
- 4** To close the card cover, push it until you hear a click.

### To Unload A Memory Card . . .

..... in step **3** push the memory card, which then comes out of the camcorder automatically. Pull it out and close the card cover.

### NOTES:

- Be sure to use only SD Memory Cards marked "**SD**" or MultiMediaCards marked "**MultiMediaCard**".
- Some brands of memory cards are not compatible with this camcorder. Before purchasing a memory card, consult its manufacturer or dealer.
- Before using a new memory card, it is necessary to **FORMAT** the card. pg. 36.

### ATTENTION

Do not insert/remove the memory card while the camcorder is turned on, as this may cause the memory card to be corrupted or cause the camcorder to become unable to recognize whether or not the card is installed.

## Picture Quality/Image Size Setting

The Picture Quality/Image Size can be selected to best match your needs. Refer to the chart on page 27 for your selection.

- 1** Set the **VIDEO/MEMORY** Switch to "MEMORY", then set the Power Switch to "**MANUAL**" while pressing down the Lock Button located on the switch. The power lamp lights and the camcorder turns on.
- 2** Press the **MENU/BRIGHT** wheel in. The Menu Screen appears.
- 3** Rotate the **MENU/BRIGHT** wheel to select "**DSC**" and press it. The DSC Menu appears.
- 4** Rotate the **MENU/BRIGHT** wheel to select "QUALITY" and press it. The Sub Menu appears. Rotate the **MENU/BRIGHT** wheel to select the desired mode and press it.
- 5** Rotate the **MENU/BRIGHT** wheel to select "IMAGE SIZE" and press it. The Sub Menu appears. Rotate the **MENU/BRIGHT** wheel to select the desired mode and press it.
- 6** Rotate the **MENU/BRIGHT** wheel to select "**RETURN**", and press it twice. The Menu Screen closes.

# TAPE RECORDING & PLAYBACK

## CONTENTS

<b>TAPE RECORDING</b> .....	16 – 20
Basic Recording .....	16
Journalistic Shooting .....	17
Self-Recording .....	17
Operation Mode .....	17
Zooming .....	18
Video Light .....	19
Time Code .....	20
<b>TAPE PLAYBACK</b> .....	21 – 24
Normal Playback .....	21
Still Playback .....	21
Shuttle Search .....	21
Frame-By-Frame Playback .....	21
Connections .....	22 – 23
Blank Search .....	24

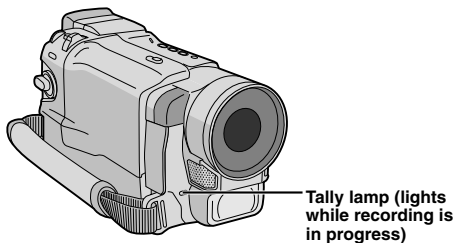
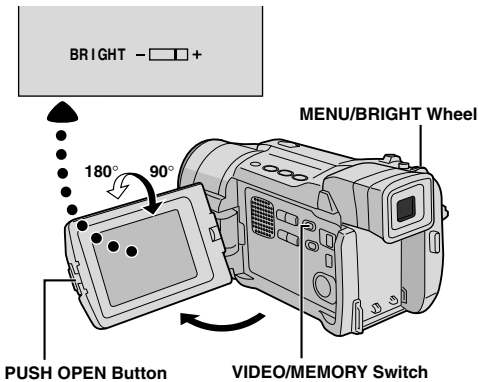
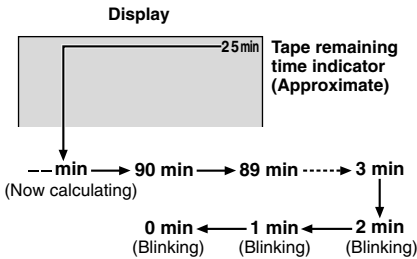
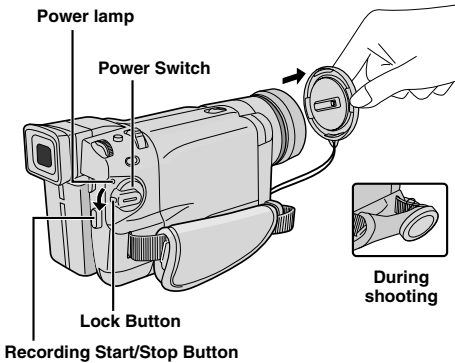

## Basic Recording

### NOTE:

You should already have performed the procedures listed below. If not, do so before continuing.

- Power (☞ pg. 8)
- Grip Adjustment (☞ pg. 10)
- Viewfinder Adjustment (☞ pg. 10)
- Load A Cassette (☞ pg. 12)
- Recording Mode Setting (☞ pg. 13)

### 1

Remove the lens cap.  
Press **PUSH OPEN**, open the LCD monitor and set the **VIDEO/MEMORY** Switch to "VIDEO".

### 2

Set the Power Switch to "**AUTO**" or "**MANUAL**" while pressing down the Lock Button located on the switch.

**Shooting while using the LCD monitor:** Make sure the LCD monitor is fully open. Tilt it upward/downward for best viewability.

**Shooting while using the viewfinder:** Close the LCD monitor.

- The power lamp lights and the camcorder enters the Record-Standby mode. "PAUSE" is displayed.

### 3

Press the Recording Start/Stop Button. "REC" appears while recording is in progress.

### To Stop Recording . . .

... press the Recording Start/Stop Button. The camcorder re-enters the Record-Standby mode.

### To Adjust The Brightness Of The Display . . .

... rotate the **MENU/BRIGHT** wheel until the bright level indicator on the display moves and the appropriate brightness is reached.

- It is also possible to adjust the brightness of the viewfinder by closing the LCD monitor and adjusting as described above.

### NOTES:

- If the Record-Standby mode continues for 5 minutes, the camcorder's power shuts off automatically. To turn the camcorder on again, set the Power Switch to "OFF", then back to "**AUTO**" or "**MANUAL**".
- The image will not appear simultaneously on the LCD monitor and the viewfinder. It will appear in the viewfinder when the LCD monitor is in the lock position, and it will appear on the LCD monitor when fully extended.
- When a blank portion is left between recorded scenes on the tape, the time code is interrupted and errors may occur when editing the tape. To avoid this, refer to "Recording from the middle of a tape" (☞ pg. 20).
- To turn the tally lamp or beep sounds off, ☞ pg. 46, 48.





To turn on the camcorder, set the Power Switch to any operation mode except "OFF" while pressing down the Lock Button located on the switch.

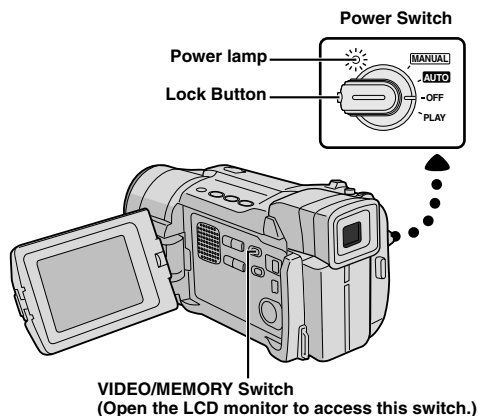

When the Power Switch is set to "AUTO", "A" appears. When set to "MANUAL" or "PLAY", there is no indication.



When the Power Switch is set to "AUTO" or "MANUAL" and the VIDEO/MEMORY Switch is set to "MEMORY", the currently selected image size appears. When set to "VIDEO", there is no indication.

## JOURNALISTIC SHOOTING

In some situations, different shooting angles may provide more dramatic results. Hold the camcorder in the desired position and tilt the LCD monitor in the most convenient direction. It can rotate 270° (90° downward, 180° upward).

## SELF-RECORDING

You can shoot yourself while viewing your own image in the LCD monitor. Open the LCD monitor and tilt it upward 180° so that it faces forward, then point the lens toward yourself and start recording.

## Operation Mode

Choose the appropriate operation mode according to your preference using the Power Switch and VIDEO/MEMORY Switch.

### Power Switch Position

#### MANUAL :

Allows you to set various recording functions using the Menus. If you want more creative capabilities than Full Auto recording, try this mode.

#### AUTO (Full Auto):

Allows you to record using NO special effects or manual adjustments. Suitable for standard recording.

#### OFF:

Allows you to switch off the camcorder.

#### PLAY:

- Allows you to play back a recording on the tape.
- Allows you to access data stored on the memory card or to transfer a still image stored on the memory card to a computer.

### VIDEO/MEMORY Switch Position

#### VIDEO:

- Allows you to record on a tape or play back a tape. If "REC SELECT" is set to "C" / "M" in the DSC Menu Screen, still images are recorded on the memory card as well.
- Zoom magnification over 10X is available (see pg. 18, 47).

#### MEMORY:

Allows you to record on a memory card or access data stored on a memory card.

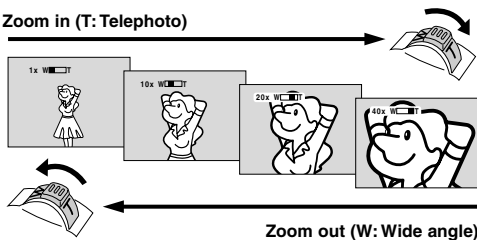
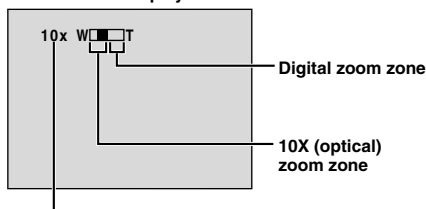
**Zoom in (T: Telephoto)****Zoom display**

Approximate zoom ratio

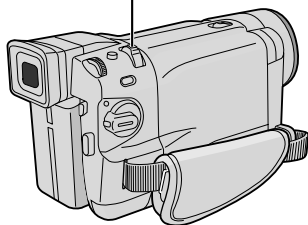
**Power Zoom Lever****FEATURE: Zooming****PURPOSE:**

To produce the zoom in/out effect, or an instantaneous change in image magnification.

**OPERATION:****Zoom In**

Slide the Power Zoom Lever towards "T".

**Zoom Out**

Slide the Power Zoom Lever towards "W".

- The further you slide the Power Zoom Lever, the quicker the zoom action.

**NOTES:**

- Focusing may become unstable during Zooming. In this case, set the zoom while in Record-Standby, lock the focus by using the manual focus (☞ pg. 43), then zoom in or out in Record mode.
- Zooming is possible to a maximum of 700X, or it can be switched to 10X magnification using the optical zoom (☞ pg. 47).
- Zoom magnification of over 10X is done through Digital image processing, and is therefore called Digital Zoom.
- During Digital zoom, the quality of image may suffer.
- Digital zoom cannot be used when the **VIDEO/MEMORY** Switch is set to "MEMORY" (☞ pg. 17).
- Macro shooting (as close as approx. 5 cm (2") to the subject) is possible when the Power Zoom Lever is set all the way to "W". Also see "TELE MACRO" in the Menu Screen on page 48.

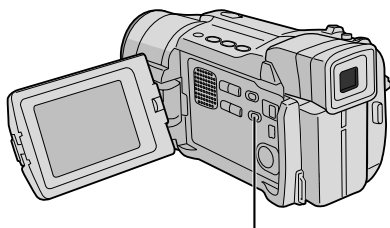

**LIGHT OFF/AUTO/ON Switch**  
(Open the LCD monitor to access this switch.)

### DANGER

- The video light can become extremely hot. Do not touch it either while in operation or soon after turning it off, otherwise serious injury may result.
- Do not place the camcorder into the carrying case immediately after using the video light, since it remains extremely hot for some time.
- When operating, keep a distance of about 30 cm (11-13/16") between the video light and people or objects.
- Do not use near flammable or explosive materials.
- Do not place the camcorder in a cabinet or box while the video light is in operation.
- When using the video light, if you wish to install the camcorder in a fixed position, attach it to a tripod, etc. Do not affix it directly to a surface such as a table top.
- It is recommended that you consult your nearest JVC dealer for replacing the video light.



### FEATURE: Video Light

#### PURPOSE:

To brighten the scene when natural lighting is too dim.

#### OPERATION:

Set **LIGHT OFF/AUTO/ON** as required:

**OFF** : Turns off the light.

**AUTO** : Automatically turns on the light when the camcorder senses insufficient lighting on the subject.

**ON** : Always keeps the light on as long as the camcorder is turned on.

- The video light can only be used with the camcorder's power on.
- It is recommended to set the white balance (☞ pg. 45) to  when you use the video light.
- When not using the video light, turn it off to save battery power.

#### NOTES:

- Even if the battery indicator (☐) does not blink due to low battery charge, the camcorder may turn off automatically when you turn on the video light, or when you start recording with the video light turned on.
- When **LIGHT OFF/AUTO/ON** is set to "AUTO":
  - Depending on the lighting conditions, the video light may keep turning on and off. In this case, manually switch the light on or off using **LIGHT OFF/AUTO/ON**.
  - While the "SHUTTER" or "SPORTS" mode (☞ pg. 39) is engaged, the light is likely to stay on.
  - While the "TWILIGHT" mode (☞ pg. 39) is engaged, the light will not activate.
  - While the "Night-Alive" mode (☞ pg. 38) is engaged, the light will not activate.

## Time Code

During recording, a time code is recorded on the tape. This code is to confirm the location of the recorded scene on the tape during playback.

If recording starts from a blank portion of the tape, the time code begins counting from "00:00:00" (minute:second:frame). If recording starts from the end of a previously recorded scene, the time code continues from the last time code number.

To perform Random Assemble Editing (☞ pg. 58 – 62), time code is necessary. If during recording a blank portion is left partway through the tape, the time code is interrupted. When recording is resumed, the time code starts counting up again from "00:00:00". This means the camcorder may record the same time codes as those existing in a previously recorded scene. To prevent this, perform "Recording From The Middle of A Tape" below in the following cases;

- When shooting again after playing back a recorded tape.
- When power shuts off during shooting.
- When a tape is removed and re-inserted during shooting.
- When shooting using a partially recorded tape.
- When shooting on a blank portion located partway through the tape.
- When shooting again after shooting a scene then opening/closing the cassette holder cover.

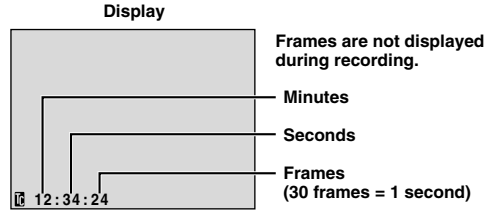

## Recording From The Middle Of A Tape

1. Play back a tape or use Blank Search (☞ pg. 24) to find the spot at which you want to start recording, then engage the Still Playback mode (☞ pg. 21).
2. Set the Power Switch to "AUTO" or "MANUAL" while pressing down the Lock Button located on the switch, then start recording.

### NOTES:

- The time code cannot be reset.
- During fast-forwarding and rewinding, the time code indication does not move smoothly.
- The time code is displayed only when "TIME CODE" is set to "ON" (☞ pg. 49, 50).

## When a blank portion is recorded on a tape

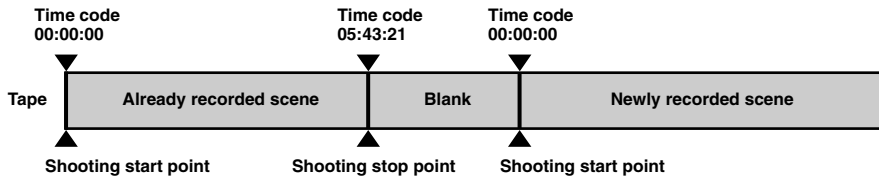

## Proper recording

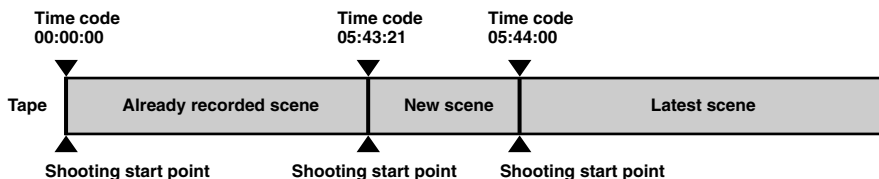

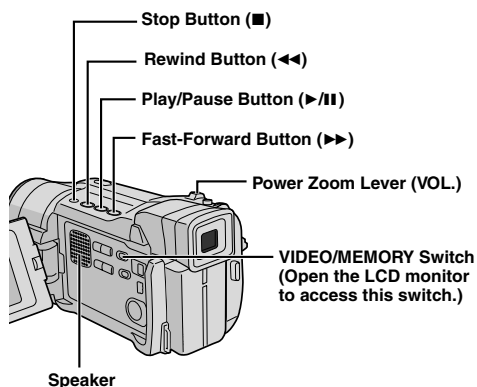

## Normal Playback

- 1** Load a tape (☞ pg. 12).
- 2** Set the **VIDEO/MEMORY** Switch to "VIDEO", then set the Power Switch to "PLAY" while pressing down the Lock Button located on the switch. To start playback, press ▶/II.
  - To stop playback, press ■.
  - Press ◀◀ to rewind, or ▶▶ to fast-forward the tape during Stop mode.

### To Control The Speaker Volume . . .

..... slide the Power Zoom Lever (**VOL.**) towards "+" to turn up the volume, or towards "-" to turn down the volume.

### NOTES:

- If Stop mode continues for 5 minutes when power is supplied from a battery, the camcorder shuts off automatically. To turn on again, set the Power Switch to "OFF", then to "PLAY".
- The playback picture can be viewed in the LCD monitor, viewfinder or on a connected TV (☞ pg. 22).
- You can also view the playback picture on the LCD monitor with it flipped over and pushed against the camera body.
- LCD monitor/viewfinder indications:
  - When power is supplied from a battery: the "☐" battery pack remaining power indicator is displayed. When power is supplied from an AC outlet: "☐" does not appear.
  - During Stop mode, none of the indications are displayed.
- When a cable is connected to the AV connector, the sound is not heard from the speaker.

### Still Playback: Pauses during playback.

- 1) Press ▶/II during playback.
  - 2) To resume normal playback, press ▶/II again.
- If still playback continues for more than about 3 minutes, the camcorder's Stop mode is automatically engaged. After 5 minutes in the Stop mode, the camcorder's power is automatically turned off.
  - When ▶/II is pressed, the image may not pause immediately while the camcorder stabilizes the still image.

### Shuttle Search: Allows high-speed search in either direction.

- 1) Press ▶▶ for forward or ◀◀ for reverse search during playback.
  - 2) To resume normal playback, press ▶/II.
- During playback, press and hold ◀◀ or ▶▶. The search continues as long as you hold the button. Once you release it, normal playback resumes.
  - A slight mosaic effect appears on screen during Shuttle Search. This is not a malfunction.

### Frame-By-Frame Playback: Allows frame-by-frame search.

- 1) Engage Still Playback.
  - 2) Rotate the **MENU/BRIGHT** wheel towards "+" for forward Frame-By-Frame Playback, or towards "-" for reverse Frame-By-Frame Playback during Still Playback.
- To resume normal playback, press ▶/II.
  - You can also use the provided remote control for Frame-By-Frame Playback (☞ pg. 56).

### Slow-Motion Playback/Playback Special Effects and Playback Zoom

Available only with the remote control (provided) (☞ pg. 56, 57).

## ATTENTION

During Shuttle Search, parts of the picture may not be clearly visible, particularly on the left side of the screen.



## Connections

These are some basic types of connections. When making the connections, refer also to your VCR and TV instruction manuals.

### A. Connection to a TV or VCR equipped with an S-VIDEO IN and A/V input connectors

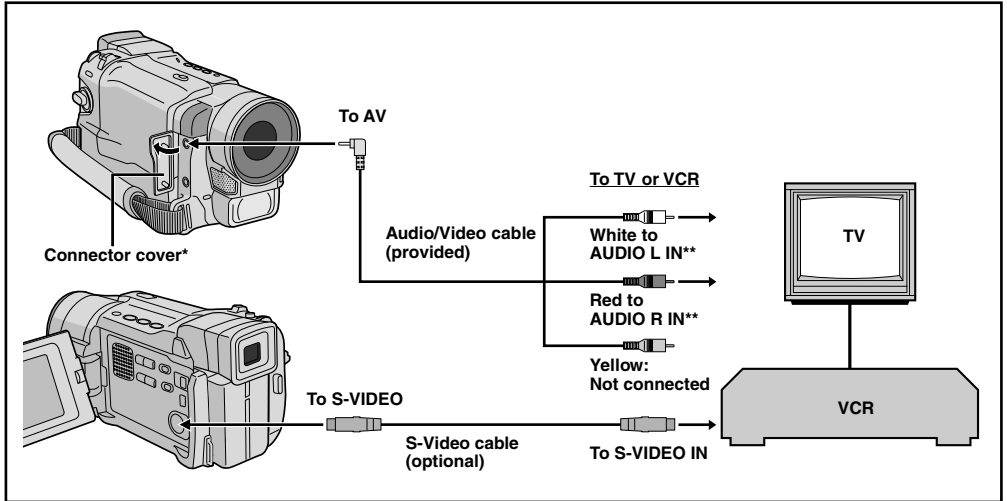

\* When connecting the cables, open this cover.

\*\* The Audio cable is not required for watching still images only.

### B. Connection to a TV or VCR equipped only with A/V input connectors

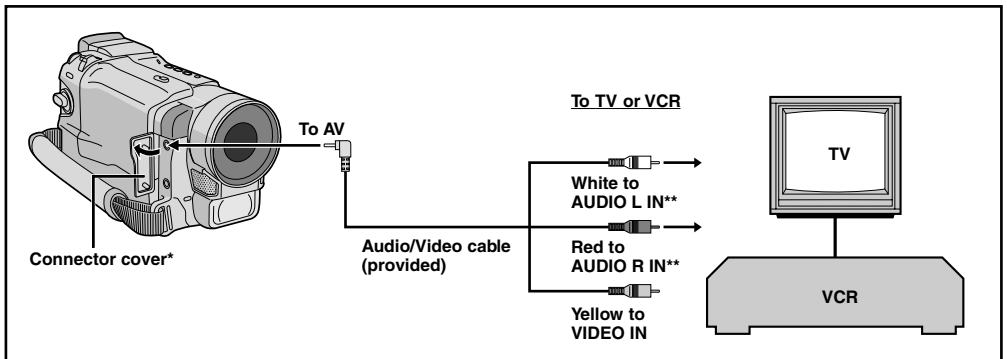

\* When connecting the cables, open this cover.

\*\* The Audio cable is not required for watching still images only.

- 1** Make sure all units are turned off.
- 2** Connect the camcorder to a TV or VCR as shown in the illustration (☞ pg. 22).  
If using a VCR . . . go to step 3.  
If not . . . go to step 4.
- 3** Connect the VCR output to the TV input, referring to your VCR's instruction manual.
- 4** Turn on the camcorder, the VCR and the TV.
- 5** Set the VCR to its AUX input mode, and set the TV to its VIDEO mode.

**To choose whether or not the following displays appear on the connected TV . . .**

- Date/Time  
..... set "DATE/TIME" to "AUTO", "ON" or "OFF" in the Menu Screen (☞ pg. 50).  
Or, press **DISPLAY** on the remote control to turn on/off the date indication.
- Time Code  
..... set "TIME CODE" to "ON" or "OFF" in the Menu Screen (☞ pg. 50).
- Playback Sound Mode, Tape Speed And Tape Running Displays for tape playback  
..... set "ON SCREEN" to "LCD" or "LCD/TV" in the Menu Screen (☞ pg. 50).

**NOTES:**

- It is recommended to use the AC Adapter as the power supply instead of the battery pack (☞ pg. 9).
- The S-Video cable is optional. Be sure to use the YTU94146A S-Video cable.  
Consult the JVC Service Center described on the sheet included in the package for details on its availability. Make sure to connect the end with a core filter to the camcorder. The core filter reduces interference.
- To monitor the picture and sound from the camcorder without inserting a tape or memory card, set the camcorder's Power Switch to "**AUTO**" or "**MANUAL**", then set your TV to the appropriate input mode.
- Make sure you adjust the TV sound volume to its minimum level to avoid a sudden burst of sound when the camcorder is turned on.
- If you have a TV or speakers that are not specially shielded, do not place the speakers adjacent to the TV as interference will occur in the camcorder playback picture.
- If no image is displayed or no sound is heard from the TV, set "S/AV INPUT" to "OFF" in the Menu Screen (☞ pg. 50).
- While the Audio/Video cable is connected to the AV connector, sound cannot be heard from the speaker.

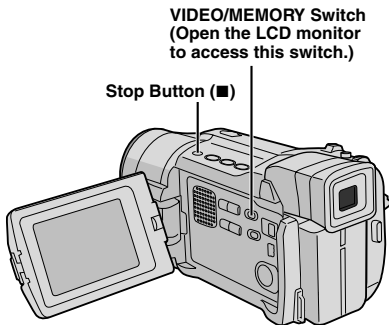
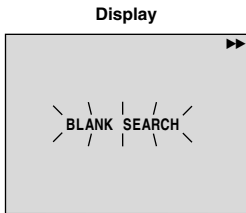
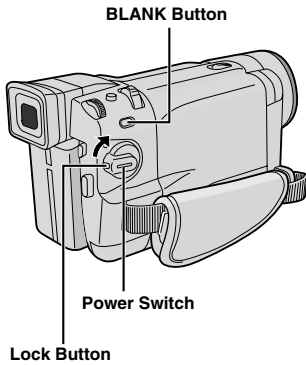

## Blank Search

Helps you find where you should start recording in the middle of a tape to avoid time code interruption (▶ pg. 20).

**1** Load a tape (▶ pg. 12).

**2** Set the **VIDEO/MEMORY Switch** to "VIDEO", then set the Power Switch to "PLAY" while pressing down the Lock Button located on the switch.

**3** Press **BLANK**.

- "BLANK SEARCH" appears blinking and the camcorder automatically starts reverse or forward shuttle search, then stops at the spot which is about 3 seconds of tape before the beginning of the detected blank portion.

**To cancel Blank Search midway . . .**

..... press ■.

### NOTES:

- In step 3, if the current position is at a blank portion the camcorder searches in the reverse direction, and if the current position is at a recorded portion the camcorder searches in the forward direction.
- Blank Search does not work if "HEAD CLEANING REQUIRED. USE CLEANING CASSETTE" has appeared with the tape.
- If the beginning or end of the tape is reached during Blank Search, the camcorder stops automatically.
- A blank portion which is shorter than 5 seconds of tape may not be detected.
- The detected blank portion may be located between recorded scenes. Before you start recording, make sure there is no recorded scene after the blank portion.



# MEMORY CARD RECORDING & PLAYBACK

## CONTENTS

<b>MEMORY CARD RECORDING</b> .....	26 – 27
Basic Shooting (Snapshot) .....	26 – 27
<b>MEMORY CARD PLAYBACK</b> .....	28 – 34
Normal Playback .....	28
Auto Playback .....	28
Index Playback .....	29
Viewing File Information .....	29
Removing On-Screen Display .....	29
<b>ADVANCED FEATURES</b> .....	30 – 36
Protecting Files .....	30
Deleting Files .....	31
Dubbing Still Images Recorded On A Tape To A Memory Card .....	32
E-Mail Clip Recording .....	33
Setting Print Information (DPOF Setting) .....	34 – 35
Making A New Folder .....	36
Initializing A Memory Card .....	36

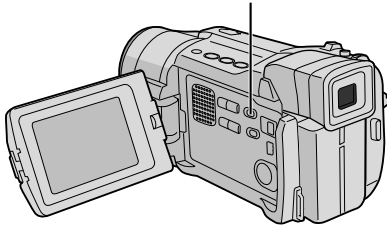
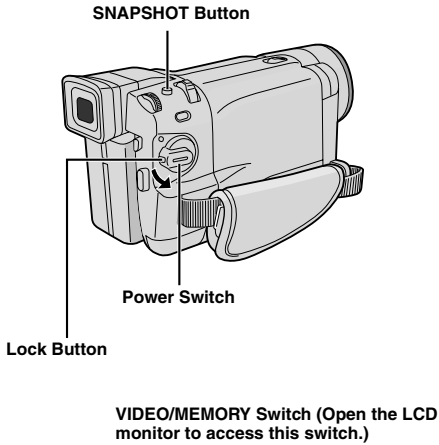

## Basic Shooting (Snapshot)

You can use your camcorder as a digital still camera for taking snapshots.

### NOTE:

You should already have performed the procedures listed below. If not, do so before continuing.

- Power (☞ pg. 8)
- Grip Adjustment (☞ pg. 10)
- Viewfinder Adjustment (☞ pg. 10)
- Loading A Memory Card (☞ pg. 14)
- Picture Quality/Image Size Setting (☞ pg. 14)

**1** Set the **VIDEO/MEMORY** Switch to “MEMORY”, then set the Power Switch to “**AUTO**” or “**MANUAL**” while pressing down the Lock Button located on the switch.

**2** Press **SNAPSHOT**. “PHOTO” appears while the snapshot is being taken.

The image is recorded on the memory card.

- Still images are recorded in the snapshot mode with no frame.

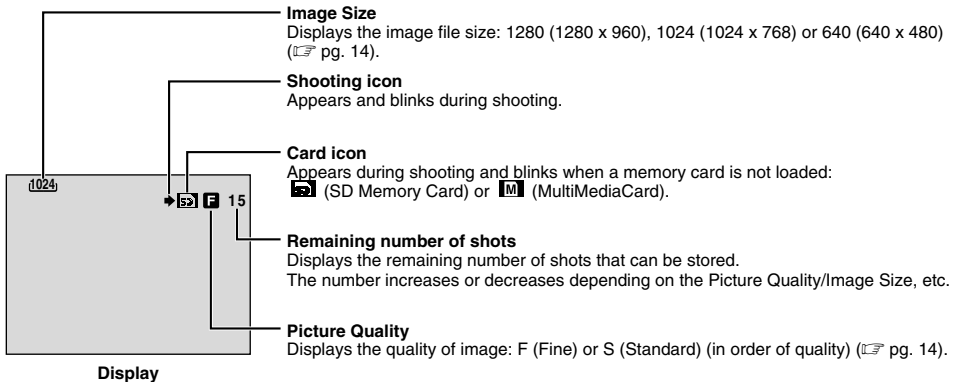



**FULL  
Snapshot mode with no  
frame**

There is the sound of a shutter closing.

**To Protect Valuable Files (available only for SD  
Memory Card) ...**

Write/erase protection tab

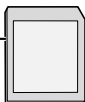

... slide the write/erase protection tab on the side of the memory card in the direction of "LOCK". This prevents the memory card from being recorded over. To record on this memory card, slide the tab back to the position opposite to "LOCK" before loading it.

**To Delete Unwanted Still Images ...**

.... when unwanted still images are stored in the memory card or its memory is full, refer to "Deleting Files" (☞ pg. 31) and delete unwanted still images.

**To Remove The Shutter Sound ...**

.... when you do not want to hear the shutter sound, set "BEEP" to "OFF" in the Menu Screen (☞ pg. 46, 48). The sound is no longer heard from the speaker.

**NOTES:**

- Even if "DIS" is set to "ON" (☞ pg. 47), the Stabilizer will be disabled.
- If Snapshot recording is not possible, "PHOTO" blinks when **SNAPSHOT** is pressed.
- If Program AE with special effects (☞ pg. 38) is engaged, certain modes of Program AE with special effects are disabled during Snapshot recording. In such a case, the icon blinks.
- If shooting is not performed for approx. 5 minutes when the Power Switch is set to "**AUTO**" or "**MANUAL**" and power is supplied from the battery pack, the camcorder shuts off automatically to save power. To perform shooting again, set the Power Switch to "OFF", then to "**AUTO**" or "**MANUAL**".
- The Motor Drive mode (☞ pg. 42) is disabled when the **VIDEO/MEMORY** Switch is set to "MEMORY".
- Still images taken are compliant to DCF (Design rule for Camera File system). They do not have any compatibility with devices which are not compliant to DCF.

**Approximate Number of Storable Images**

Image Size/Picture Quality	SD Memory Card				MultiMediaCard		
	8MB**	16MB**	32MB**	64MB**	8MB**	16MB*	32MB**
1280 x 960/FINE	12	28	62	120	16	32	64
1280 x 960/ STANDARD	44	98	205	405	50	100	200
1024 x 768/FINE	20	46	98	190	25	50	100
1024 x 768/ STANDARD	66	145	310	605	80	160	320
640 x 480/FINE	46	98	205	405	50	105	210
640 x 480/ STANDARD	150	295	625	1215	160	320	640

\* Provided

\*\* Optional

**NOTE:**

The number of storable images depends on the selected picture quality as well as the composition of the subjects in the images and the type of memory card being used.

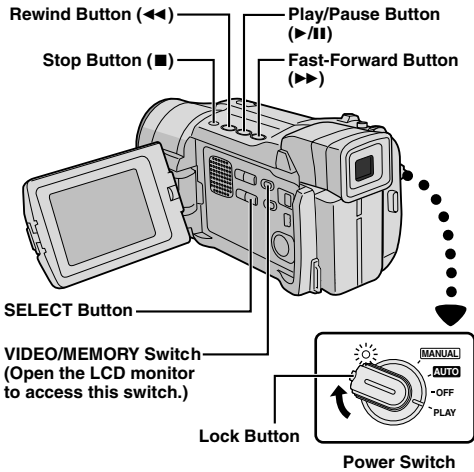

[For Normal Playback: IMAGE]

To display the next image

To display the previous image

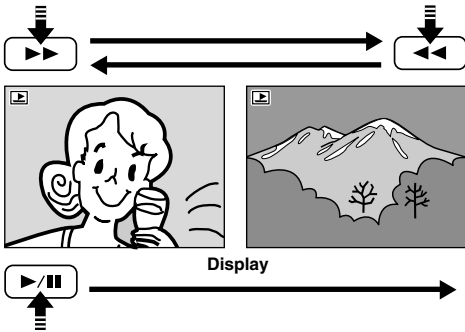

[For Auto Playback: IMAGE]

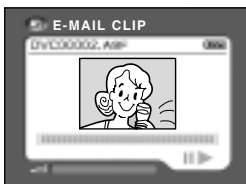

Normal Playback:  
E-MAIL CLIP

## Normal Playback

Images shot with the camcorder are automatically numbered, then stored in numerical order on the memory card. You can view the stored images, one at a time, much like flipping through a photo album.

**1** Load a memory card (☞ pg. 14).

**2** Set the **VIDEO/MEMORY** Switch to "MEMORY", then set the Power Switch to "PLAY" while pressing down the Lock Button.

• The type of file playback last time is played.

**3** If you want to select another type of file, press **SELECT**. The MEMORY SELECT Screen appears. Rotate the **MENU/BRIGHT** wheel to select the type of file: **IMAGE** or **E-MAIL CLIP** (☞ pg. 33). Then press the **MENU/BRIGHT** wheel in. The selected type of file is displayed.

**4** If you are viewing an **IMAGE** file . . .

Press **▶▶** to display the next image, or press **◀◀** to display the previous image.

If you are viewing an **E-MAIL CLIP** file . . .

Press **▶/||** to play back the displayed video clip. To stop video clip playback, press **■**.

### NOTES:

- Pressing **INFO** gives you details on the displayed file (☞ pg. 29, "Viewing File Information").
- You can also overview several files at a time (☞ pg. 29, Index Playback).
- You can turn off the on-screen playback display (☞ pg. 29, "Removing On-Screen Display").

## Auto Playback

You can run through all the images stored on memory automatically.

**1** Perform steps 1 and 2 above.

**2** Press **▶/||**.

- If you press **◀◀** during Auto Playback, images are displayed in descending order.
- If you press **▶▶** during Auto Playback, images are displayed in ascending order.

**3** To end Auto Playback, press **■**.

### NOTE:

- Even if you shoot a new image after playing back a low-numbered one, this will not overwrite an existing image, because new images are automatically stored after the last-recorded one.
- Images shot in a file size that is not compatible with this camcorder will be displayed as reduced-size thumbnail images. These thumbnail images cannot be transferred to a PC.
- Images shot with devices (such as JVC GR-DVM70) that are not compatible with DCF cannot be viewed with this camcorder; "UNSUPPORTED FILES" will be displayed.

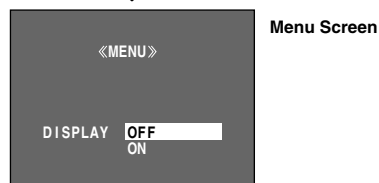
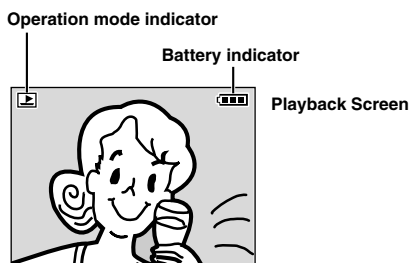
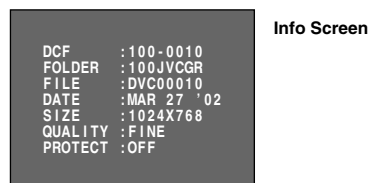
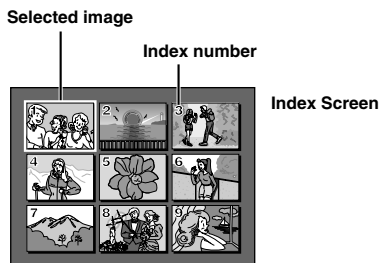
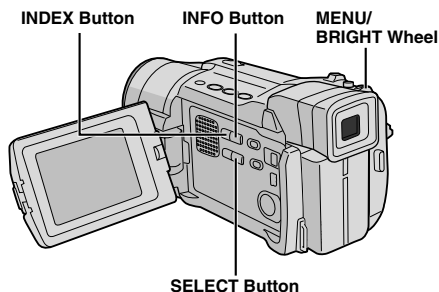

## Index Playback

You can view several different files stored on the memory card at a time. This browsing capability makes it easy to locate a particular file you want.

- 1 Perform steps 1 through 3 of "Normal Playback".
- 2 Press **INDEX**. The Index Screen appears.
- 3 Rotate the **MENU/BRIGHT** wheel to move the frame to the desired file.
  - Pressing **▶▶** displays the next page and **◀◀** displays the previous page.
  - Pressing **INFO** gives you details on the currently selected file (☞ "Viewing File Information").
- 4 Press the **MENU/BRIGHT** wheel in. The selected file is displayed.
  - Pressing **INFO** gives you details on the displayed file (☞ "Viewing File Information").

## Viewing File Information

You can get the relevant file information by pressing the **INFO** button during normal playback or Index playback.

- DCF : Folder and file number (IMAGE files only)  
 FOLDER : Folder name (☞ pg. 36)  
 FILE : File name (☞ pg. 36)  
 DATE : Date the file was made  
 SIZE : Image size (☞ pg. 14)  
 QUALITY : Picture quality  
 (IMAGE files only ☞ pg. 14)  
 TIME : Playback time (E-MAIL CLIP files only ☞ pg. 33)  
 PROTECT : When set to ON, the file is protected from accidental erasure (☞ pg. 30).
- Press **INFO** again to close the Info Screen.

### NOTE:

With images shot with another device or processed on a PC, "QUALITY: ---" will be displayed.

## Removing On-Screen Display

- 1 Perform steps 1 and 2 of "Normal Playback" (☞ pg. 28).
- 2 Make sure an IMAGE file is displayed (☞ pg. 28); if not, press **SELECT** to access the MEMORY SELECT Screen. Rotate the **MENU/BRIGHT** wheel to select "IMAGE" and press it.
- 3 Press the **MENU/BRIGHT** wheel in. The Menu Screen appears. Rotate the **MENU/BRIGHT** wheel to select "DISPLAY", then press it.
- 4 Rotate the **MENU/BRIGHT** wheel to select "OFF", then press it. The operation mode indicator and battery indicator (☞) disappear.
  - To display the indicators again, select "ON" in step 4.

MENU/BRIGHT Wheel

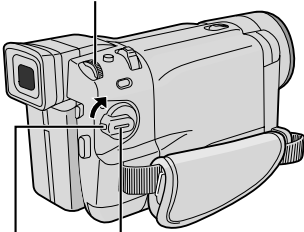

Power Switch

Lock Button

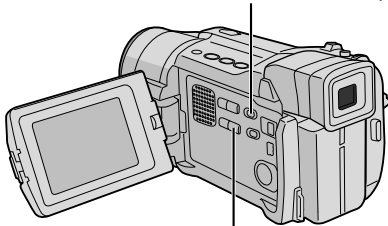
VIDEO/MEMORY Switch  
(Open the LCD monitor to access this switch.)

SELECT Button

Display



Menu Screen



PROTECT Screen

## Protecting Files

The Protect mode helps prevent the accidental erasure of files.

- 1** Load a memory card (➤ pg. 14).
- 2** Set the **VIDEO/MEMORY** Switch to “MEMORY”, then set the Power Switch to “PLAY” while pressing down the Lock Button located on the switch.
  - A stored file is displayed.
- 3** If you want to select another type of file, press **SELECT**. The MEMORY SELECT Screen appears. Rotate the **MENU/BRIGHT** wheel to select the type of file: IMAGE or E-MAIL CLIP (➤ pg. 33). Then press the **MENU/BRIGHT** wheel in. The selected type of file is displayed.
- 4** Press the **MENU/BRIGHT** wheel in. The Menu Screen appears. Rotate the **MENU/BRIGHT** wheel to select “PROTECT”, then press it.
- 5** Rotate the **MENU/BRIGHT** wheel to select the desired mode.
  - CURRENT : Protects the currently displayed file.
  - PROT.ALL : Protects all files stored on the memory card.
- 6** Press the **MENU/BRIGHT** wheel in. The PROTECT Screen appears.
  - If you selected “CURRENT” in step 5, press ◀◀ or ▶▶ to select the desired file.
- 7** Rotate the **MENU/BRIGHT** wheel to select “EXECUTE” and press it.
  - To cancel protection, select “RETURN”.

### NOTES:

- If the “On” mark appears, the currently displayed file is protected.
- When the memory is initialised or corrupted, even protected files are deleted. If you do not want to lose important files, transfer them to a PC and save them.

## TO REMOVE PROTECTION

Before doing the following, perform steps 1 through 4 above.

- 5** Rotate the **MENU/BRIGHT** wheel to select the desired mode.
  - CURRENT : Removes protection from the currently displayed file.
  - CANC.ALL : Removes protection from all files stored on the memory card.
- 6** Press the **MENU/BRIGHT** wheel in. The PROTECT Screen appears.
  - If you selected “CURRENT”, press ◀◀ or ▶▶ to select the desired file.
- 7** Rotate the **MENU/BRIGHT** wheel to select “EXECUTE” and press it.
  - To cancel selection, select “RETURN”.

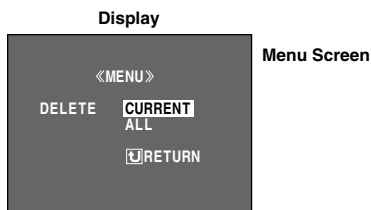
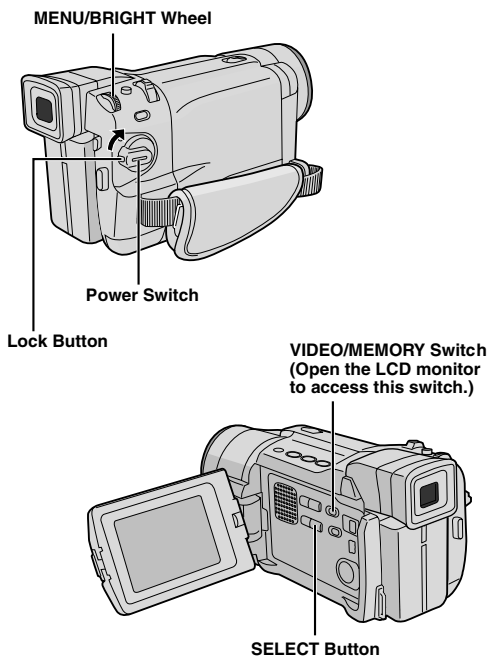

### CAUTION

Do not remove the memory card or perform any other operation (such as turning off the camcorder) during deletion. Also, be sure to use the provided AC Adapter, as the memory card may be corrupted if the battery becomes exhausted during deletion. If the memory card becomes corrupted, initialize it. (pg. 36)

## Deleting Files

Previously stored files can be deleted either one at a time or all at once.

- 1** Load a memory card (pg. 14).
- 2** Set the **VIDEO/MEMORY** Switch to "MEMORY", then set the Power Switch to "PLAY" while pressing down the Lock Button located on the switch.
  - A stored file is displayed.
- 3** If you want to select another type of file, press **SELECT**. The MEMORY SELECT Screen appears. Rotate the **MENU/BRIGHT** wheel to select the type of file: IMAGE or E-MAIL CLIP (pg. 33). Then press the **MENU/BRIGHT** wheel in. The selected type of file is displayed.
- 4** Press the **MENU/BRIGHT** wheel in. The Menu Screen appears. Rotate the **MENU/BRIGHT** wheel to select "DELETE", then press it.
- 5** Rotate the **MENU/BRIGHT** wheel to select the desired mode.
  - CURRENT : Deletes the currently displayed file.
  - ALL : Deletes all files stored on the memory card.
- 6** Press the **MENU/BRIGHT** wheel in. The DELETE Screen appears.
  - If you selected "CURRENT" in step 5, press ◀ or ▶ to select the desired file.
- 7** Rotate the **MENU/BRIGHT** wheel to select "EXECUTE" and press it.
  - If the "ON" mark appears, the selected file is protected and cannot be deleted (pg. 30).
  - To cancel deletion, select "RETURN".

### NOTES:

- Protected files (pg. 30) cannot be deleted with the above operation. To delete them, remove protection first.
- Once files are deleted, they cannot be restored. Check files before deleting.

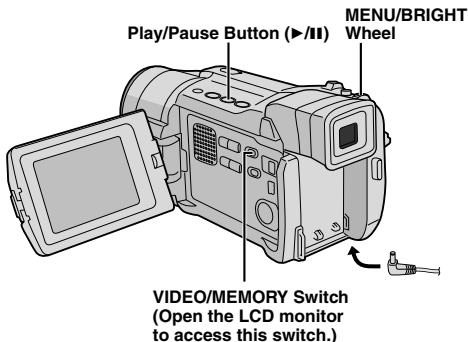
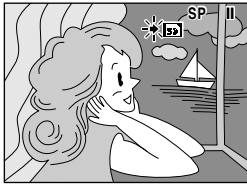
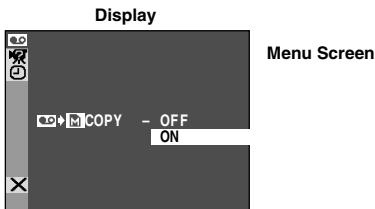
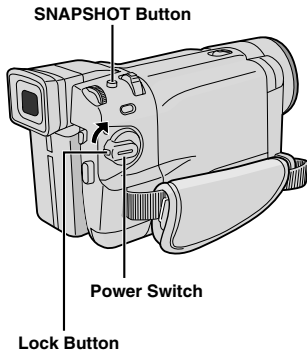

## Dubbing Still Images Recorded On A Tape To A Memory Card

Still images can be dubbed from a tape to a memory card.

- 1** Load a memory card (☞ pg. 14) and cassette (☞ pg. 12).
- 2** Set the **VIDEO/MEMORY** Switch to "VIDEO", then set the Power Switch to "PLAY" while pressing down the Lock Button.
- 3** Press the **MENU/BRIGHT** wheel in. The Menu Screen appears. Rotate it to select "VIDEO" and press it. The VIDEO Menu appears.
- 4** Rotate the **MENU/BRIGHT** wheel to select "COPY" and press it. The Sub Menu appears. Rotate it to select "ON" and press it. Selection is complete.
- 5** Rotate the **MENU/BRIGHT** wheel to select "RETURN" and press it twice. The normal playback screen reappears.
- 6** To select a video image to be dubbed, start playback by pressing ▶/II. At the moment you find the image you wish to dub, press it again to engage Still Playback.
- 7** To start dubbing, press **SNAPSHOT**. The selected image is stored on the memory card.
  - "▶" blinks during dubbing.

### NOTES:

- If **SNAPSHOT** is pressed in step 7 when a memory card is not loaded, the message "COPYING FAILED" is displayed.
- If an image recorded on the tape using the **WIDE** mode (☞ pg. 48) is dubbed to a memory card, the **WIDE** mode identifying signal is not dubbed with it.
- To use Playback Special Effects with a video image you wish to dub, perform up to step 7 using the remote control (☞ pg. 56).
- Images are dubbed in 640 x 480 pixels.



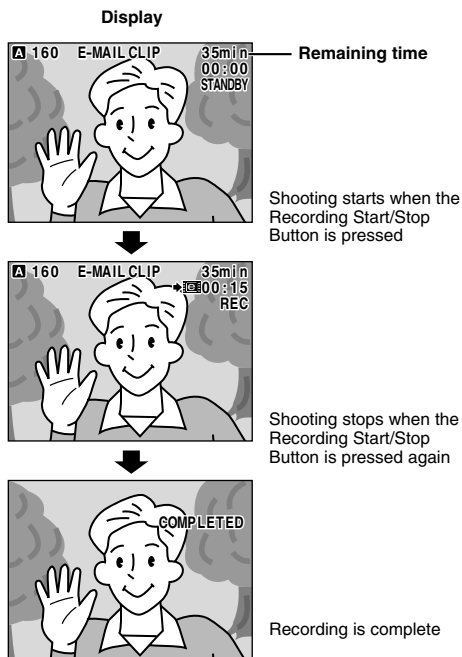

## E-Mail Clip Recording

You can make video clips from real-time camera image or recorded video footage and store them in a memory card as files which can be conveniently sent via e-mail.

### TO MAKE VIDEO CLIPS FROM REAL-TIME CAMERA IMAGE

- 1 Load a memory card ( pg. 14). Set the **VIDEO/MEMORY** Switch to "MEMORY", then set the Power Switch to "**AUTO**" or "**MANUAL**" while pressing down the Lock button located on the switch.
- 2 Press **E-MAIL**. The camcorder enters the E-Mail Clip Record-Standby mode.
- 3 Press the Recording Start/Stop Button to start shooting.
- 4 Press the Recording Start/Stop Button to stop shooting. "COMPLETED" is displayed, then the camcorder re-enters the E-Mail Clip Record-Standby mode.
- 5 Press **E-MAIL** to end E-Mail Clip Recording. The normal screen reappears.

**To view video clips stored on a memory card . . .**  
 ..... ( pg. 28, 29.

### TO MAKE VIDEO CLIPS FROM RECORDED VIDEO FOOTAGE

- 1 Load a memory card ( pg. 14) and cassette ( pg. 12). Set the **VIDEO/MEMORY** Switch to "VIDEO", then set the Power Switch to "PLAY" while pressing down the Lock Button located on the switch.
- 2 Press **▶/II** to start tape playback.
- 3 Press **E-MAIL**. "E-MAIL CLIP STANDBY" appears and the camcorder enters the E-Mail Clip Record-Standby mode.
- 4 Press the Recording Start/Stop Button to start E-Mail Clip Recording.
- 5 Press the Recording Start/Stop Button to stop E-Mail Clip Recording. "COMPLETED" is displayed, then the camcorder re-enters the E-Mail Clip Record-Standby mode.
- 6 Press **E-MAIL** to end E-Mail Clip Recording. The normal screen reappears.

**To cancel E-Mail Clip Recording . . .**  
 ..... after step 3, press **E-MAIL** again or press **■** to stop tape playback.

**To view video clips stored on a memory card . . .**  
 ..... ( pg. 28, 29.

#### NOTES:

- Video clips are stored in 160 x 120-pixel format.
- Playback operation cannot be performed during E-Mail Clip Recording.
- If the end of the tape is reached in step 3, the E-Mail Clip Record-Standby mode will be automatically cancelled.
- The video clip files made with this camcorder are MPEG4 compliant, however, some MPEG4 files made with other devices may not be played back with this camcorder.
- You can delete unwanted video clips ( pg. 31, "Deleting Files") or protect important ones from accidental erasure ( pg. 30, "Protecting Files").
- Video noise may appear while viewing video clips in the LCD monitor or viewfinder, however, this noise is not present in the actual video clips stored on the memory card.
- You can also view video clips on your PC by using Windows® Media Player. Refer to the instructions of the PC and software.

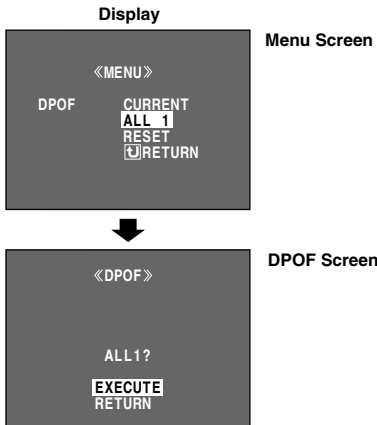
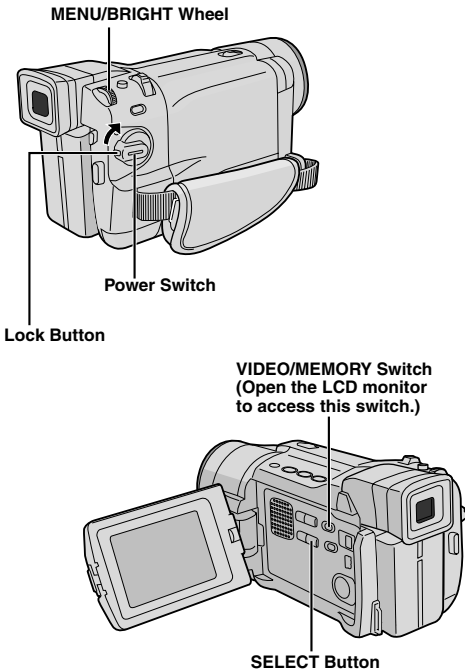

## Setting Print Information (DPOF Setting)

This camcorder is compatible with the DPOF (Digital Print Order Format) standard in order to support future systems such as automatic printing, which records information about the still images you wish to print (such as the number of prints to make). There are 2 print information settings available: "To print all still images (one print for each)" explained below and "To print by selecting still images and no. of prints" (pg. 35).

### TO PRINT ALL STILL IMAGES (ONE PRINT FOR EACH)

- 1** Set the **VIDEO/MEMORY** switch to "MEMORY", then set the Power Switch to "PLAY", while pressing down the Lock Button located on the switch.
  - A stored file is displayed.
- 2** Make sure an **IMAGE** file is displayed (pg. 28); if not, press **SELECT** to access the **MEMORY SELECT** Screen. Rotate the **MENU/BRIGHT** wheel to select "IMAGE" and press it.
- 3** Press the **MENU/BRIGHT** wheel in. The Menu Screen appears.
- 4** Rotate the **MENU/BRIGHT** wheel to select "DPOF" and press it. The Sub Menu appears.
- 5** Rotate the **MENU/BRIGHT** wheel to select "ALL 1" and press it. Selection is complete. The DPOF Screen appears.
- 6** Rotate the **MENU/BRIGHT** wheel to select "EXECUTE" and press it. The normal playback screen appears.
  - To cancel selection, rotate the **MENU/BRIGHT** wheel to select "RETURN" and press it.

#### To Reset The Setting . . .

..... select "RESET" in step 5. The setting is reset to 0 for all still images.

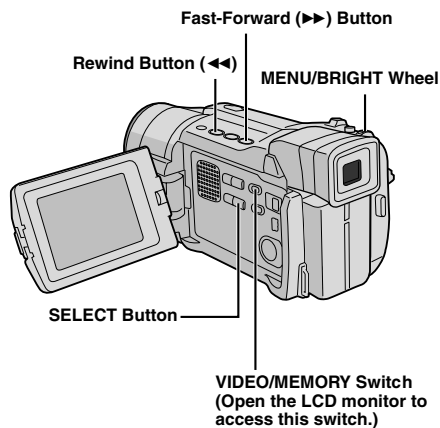

## TO PRINT BY SELECTING STILL IMAGES AND NO. OF PRINTS

- 1** Perform steps 1 through 4 on pg. 34.
- 2** Rotate the **MENU/BRIGHT** wheel to select “CURRENT” and press it. Selection is complete. The DPOF Screen appears.
- 3** Press ◀◀ or ▶▶ so that the image you wish to print appears.
- 4** Rotate the **MENU/BRIGHT** wheel to move the highlight bar to the SHEETS number indication and press it.
- 5** Select the number of prints by rotating the **MENU/BRIGHT** wheel and press it.  
Repeat steps 3 through 5 for the desired number of prints.
  - The number of prints can be set up to 15.
  - To correct the number of prints, select the image again and change the number.
- 6** Rotate the **MENU/BRIGHT** wheel to select “RETURN” and press it. Selection is complete. “SAVE?” appears.
  - If you did not change any settings in step 3 through 5, the Menu Screen reappears.
- 7** Rotate the **MENU/BRIGHT** wheel to select “EXECUTE”, then press it to save the setting you have just made.
  - To cancel selection, rotate the **MENU/BRIGHT** wheel to select “CANCEL” and press it.

### To Reset The No. Of Prints . . .

..... select “RESET” in step 5 on pg. 34. The number of prints is reset to 0 for all still images.

### CAUTION

While performing the above, never disconnect power, as this may cause the memory to be corrupted. For safety, all buttons including the Power Switch are disabled in step 6.

### NOTES:

- “BATTERY LOW” appears if the battery remaining power is too low.
- If you load a memory card already set as shown above in a printer compatible with DPOF, it will make prints of the selected still images automatically.
- To print images recorded on a tape, first dub them to a memory card (▶▶ pg. 32).

**Folder and File names**

Each time shooting takes place, a file name is made using a number which is larger by one than the largest number of the file names which are in use. Even if you delete an image file with a number in the middle of range, the number will not be used for a new shot; a gap will remain in the numerical sequence. If the file name reaches DVC09999, a new folder (such as "101JVCGR") will be made and the file name will start again from DVC00001.

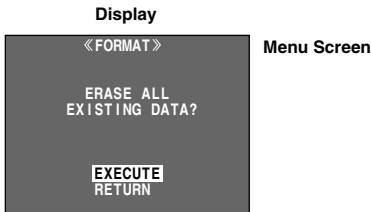
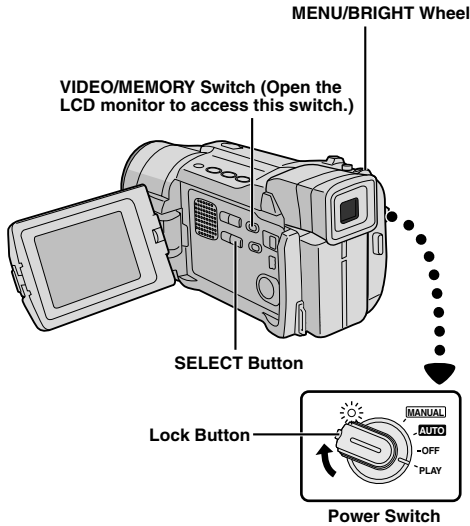
**Making A New Folder**

New still pictures you are going to take can be separated from previously shot pictures by resetting the file name to DVC00001; these new pictures will be stored in a new folder.

- 1 Set the **VIDEO/MEMORY** Switch to "MEMORY", then set the Power Switch to "PLAY" while pressing down the Lock Button located on the switch.
  - A stored file is displayed.
- 2 Make sure an **IMAGE** file is displayed (pg. 28); if not, press **SELECT** to access the MEMORY SELECT Screen. Rotate the **MENU/BRIGHT** wheel to select "IMAGE" and press it.
- 3 Press the **MENU/BRIGHT** wheel in. The Menu Screen appears. Rotate the **MENU/BRIGHT** wheel to select "NO. RESET", then press it. The NO. RESET Screen appears.
- 4 Rotate the **MENU/BRIGHT** wheel to select "EXECUTE", then press it. The new folder (such as "101JVCGR") will be made and the file name of the next shot starts from DVC00001.

**Initializing A Memory Card**

You can initialize a memory card anytime.

**After initializing, all files and data stored on the memory card, including those which have been protected, are cleared.**

- 1 Perform step 1 of "Making A New Folder" above.
- 2 Press the **MENU/BRIGHT** wheel in. The Menu Screen appears. Rotate the **MENU/BRIGHT** wheel to select "FORMAT" and press it. The FORMAT Screen appears.
- 3 Rotate the **MENU/BRIGHT** wheel to select "EXECUTE" and press it. The memory card is initialized. When initialization is finished, "NO IMAGES STORED" or "NO E-MAIL CLIP STORED" appears.
  - To cancel initialization, rotate the **MENU/BRIGHT** wheel to select "RETURN" and press it.

**CAUTION**

Do not perform any other operation (such as turning off the camcorder) during initialization. Also, be sure to use the provided AC Adapter, as the memory card may be corrupted if the battery becomes exhausted during initialization. If the memory card becomes corrupted initialize it.

# ADVANCED FEATURES

## CONTENTS

<b>FOR RECORDING</b> .....	38 – 39
Night-Alive .....	38
Program AE With Special Effects .....	38 – 39
Fade/Wipe Effects .....	40 – 41
Snapshot (For Tape Recording) .....	42
Auto Focus/Manual Focus .....	43
Exposure Control .....	44
Iris Lock .....	44
White Balance Adjustment .....	45
Manual White Balance Operation .....	45
<b>USING MENUS FOR DETAILED ADJUSTMENT</b> .....	46 – 51
For Recording Menu .....	46 – 49
For Playback Menu .....	50 – 51
<b>DUBBING</b> .....	52 – 53
Dubbing To Or From A VCR .....	52
Dubbing To Or From A Video Unit Equipped With A DV Connector ....	53
<b>USING THE REMOTE CONTROL UNIT</b> .....	54 – 64
Installing The Batteries .....	54
Slow-Motion Playback .....	56
Frame-By-Frame Playback .....	56
Playback Special Effects .....	56
Playback Zoom .....	57
Random Assemble Editing .....	58 – 62
For More Accurate Editing .....	62
Audio Dubbing .....	63
Insert Editing .....	64
<b>SYSTEM CONNECTIONS</b> .....	65 – 66
Connection To A Personal Computer .....	65
Using The Camcorder As A WebCam .....	66

**NOTES:**

- During Night-Alive, the following functions or settings cannot be activated and its indicator blinks or goes out.
  - Some modes of "Program AE With Special Effects" (☞ pg. 38, 39).
  - "GAIN UP" in the CAMERA Menu (☞ pg. 47).
  - "DIS" in the MANUAL Menu (☞ pg. 47).
  - "Video light" when **LIGHT OFF/AUTO/ON** is set to "AUTO" (☞ pg. 19).
- During Night-Alive, it may be difficult to bring the camcorder into focus. To prevent this, use of manual focus and/or a tripod is recommended.

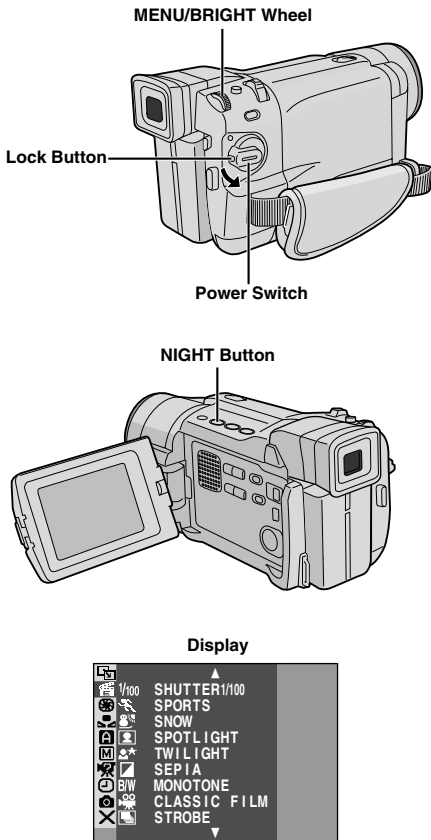
**Night-Alive**

Makes dark subjects or areas even brighter than they would be under good natural lighting. Although the recorded image is not grainy, it may look as if it is strobing due to the slow shutter speed.

- 1 Set the Power Switch to "MANUAL" while pressing down the Lock Button located on the switch.
- 2 Press **NIGHT** so that the Night-Alive indicator "🌙" appears.
  - The shutter speed is automatically adjusted to provide up to 30 times sensitivity.
  - "A" appears beside "🌙" while the shutter speed is being automatically adjusted.

**To Deactivate Night-Alive . . .**

..... press **NIGHT** again so that the Night-Alive indicator disappears.

**Program AE With Special Effects**

- 1 Set the Power Switch to "MANUAL" while pressing down the Lock Button located on the switch.
- 2 Press the **MENU/BRIGHT** wheel in. The Menu Screen appears.
- 3 Rotate the **MENU/BRIGHT** wheel to select "PROGRAM AE", then press it.
- 4 Rotate the **MENU/BRIGHT** wheel to select the desired mode (☞ pg. 39), then press it. Selection is complete. Press the **MENU/BRIGHT** wheel in again. The Menu Screen closes.
  - The PROGRAM AE Menu disappears and the selected mode is activated. The selected mode indicator appears.

**To Deactivate The Selected Mode . . .**

..... select "OFF" in step 4.

**NOTES:**

- Program AE with special effects can be changed during recording or during Record-Standby.
- Some modes of Program AE special effects cannot be used during Night-Alive.

**IMPORTANT**

Some modes of Program AE with special effects cannot be used with certain Fade/Wipe Effects (☞ pg. 40, 41). If an unusable mode is selected, its indicator blinks or goes out.

**SHUTTER**

**1/60**—The shutter speed is fixed at 1/60th of a second. Black bands that usually appear when shooting a TV screen become narrower.

**1/100**—The shutter speed is fixed at 1/100th of a second. The flickering that occurs when shooting under a fluorescent light or mercury-vapor lamp is reduced.



 **SPORTS**  
(Variable  
Shutter Speed:  
1/250 – 1/4000)

This setting allows fast-moving images to be captured one frame at a time, for vivid, stable slow-motion playback. The faster the shutter speed, the darker the picture becomes. Use the shutter function under good lighting conditions.

**SNOW**

Compensates for subjects that may otherwise appear too dark when shooting in extremely bright surroundings such as in the snow.

**SPOTLIGHT**

Compensates for subjects that may otherwise appear too bright when shooting under extremely strong direct lighting such as spotlights.

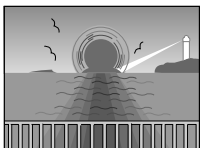

**NOTE:**

“SPOTLIGHT” has the same effect as -3 with the exposure control ( pg. 44).



 **TWILIGHT**

Makes evening scenes look more natural.

White Balance ( pg. 45) is initially set to , but can be changed to your desired setting. When Twilight is chosen, the camcorder automatically adjusts the focus from approx. 10 m (32 ft) to infinity. From less than 10 m (32 ft), adjust the focus manually.

 **SEPIA**

Recorded scenes have a brownish tint like old photos. Combine this with the Cinema mode for a classic look.

**B/W MONOTONE**

Like black and white films, your footage is shot in B/W. Used together with the Cinema mode, it enhances the “classic film” effect.



 **CLASSIC FILM**

Gives recorded scenes a strobe effect.



 **STROBE**

Your recording looks like a series of consecutive snapshots.

**IMPORTANT**

Some Fade/Wipe Effects cannot be used with certain modes of Program AE with special effects (pg. 38, 39). If an unusable Fade/Wipe Effect is selected, its indicator blinks or goes out.

Lock Button

MENU/BRIGHT Wheel

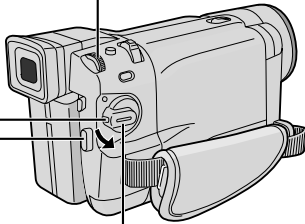

Power Switch

Recording Start/Stop Button

VIDEO/MEMORY Switch  
(Open the LCD monitor to access this switch.)

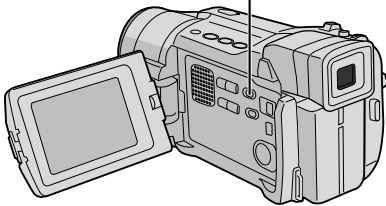
**Fade/Wipe Effects**

These effects let you make pro-style scene transitions. Use them to spice up the transition from one scene to the next.

Fade or Wipe works when tape recording is started or when you stop recording.

**1** Set the **VIDEO/MEMORY** Switch to "VIDEO", then set the Power Switch to "**MANUAL**" while pressing down the Lock Button located on the switch.

**2** Press the **MENU/BRIGHT** wheel in. The Menu Screen appears.

**3** Rotate the **MENU/BRIGHT** wheel to select "**WIPE/FADER**", then press it.

**4** Rotate the **MENU/BRIGHT** wheel to select the desired function, then press it. Selection is complete. Press the **MENU/BRIGHT** wheel in again.

- The **WIPE/FADER** Menu disappears and the effect is reserved. The indicator representing the selected effect appears.

**5** Press the Recording Start/Stop Button to activate the Fade-in/out or Wipe-in/out.

**To Deactivate The Selected Effect . . .**









..... select "OFF" in step 4.

**NOTE:**

You can extend the length of a Fade or Wipe by pressing and holding the Recording Start/Stop Button.



## Fader And Wipe Menu

Menu	Effect
 <b>FADER — WHITE</b>	Fade in or out with a white screen.
 <b>FADER — BLACK</b>	Fade in or out with a black screen.
 <b>FADER — B.W</b>	Fade in to a color screen from a black and white screen, or fade out from color to black and white.
 <b>WIPE — CORNER</b>	Wipe in on a black screen from the upper right to the lower left corner, or wipe out from lower left to upper right, leaving a black screen.
 <b>WIPE — WINDOW</b>	The scene starts in the center of a black screen and wipes in toward the corners, or comes in from the corners, gradually wiping out to the center.
 <b>WIPE — SLIDE</b>	Wipe in from right to left, or wipe out from left to right.
 <b>WIPE — DOOR</b>	Wipe in as the two halves of a black screen open to the left and right, revealing the scene, or wipe out and the black screen reappears from left and right to cover the scene.
 <b>WIPE — SCROLL</b>	The scene wipes in from the bottom to the top of a black screen, or wipes out from top to bottom, leaving a black screen.
 <b>WIPE — SHUTTER</b>	Wipe in from the center of a black screen toward the top and bottom, or wipe out from the top and bottom toward the center leaving a black screen.

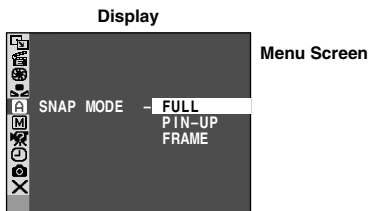
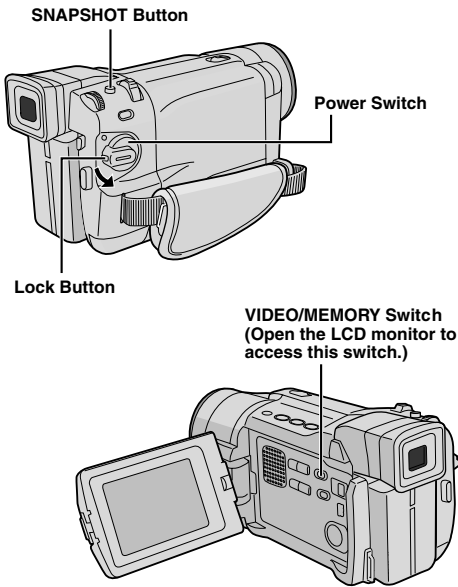

**FULL**  
Snapshot mode  
with no frame



**PIN-UP**  
Pin-Up mode



**FRAME**  
Snapshot mode  
with frame

## Snapshot (For Tape Recording)

This feature lets you record still images that look like photographs onto a tape.

### SNAPSHOT MODE SELECTION

- 1 Set the **VIDEO/MEMORY** Switch to "VIDEO", then set the Power Switch to "**MANUAL**" while pressing down the Lock Button located on the switch.
- 2 Press the **MENU/BRIGHT** wheel in. The Menu Screen appears.
- 3 Rotate the **MENU/BRIGHT** wheel to select "**A** CAMERA". Press it and the CAMERA Menu appears.
- 4 Rotate the **MENU/BRIGHT** wheel to select "SNAP MODE", then press it.
- 5 Rotate the **MENU/BRIGHT** wheel to select the desired Snapshot mode, then press it. Rotate the **MENU/BRIGHT** wheel to select "**U** RETURN" and press it twice. The Menu Screen closes.

### SNAPSHOT RECORDING

- 1 Press **SNAPSHOT**. "PHOTO" appears while the snapshot is being taken.

**If you press during Record-Standby . . .**

..... "PHOTO" appears and a still image will be recorded for approx. 6 seconds, then the camcorder re-enters the Record-Standby mode.

**If you press during Recording . . .**

..... "PHOTO" appears and a still image will be recorded for approx. 6 seconds, then the normal recording resumes.

- Regardless of the Power Switch position ("AUTO" or "MANUAL"), Snapshot recording takes place using the selected Snapshot mode.

#### Motor Drive Mode

Keeping **SNAPSHOT** pressed provides an effect similar to serial photography. (Interval between still images: approx. 1 second)

#### NOTES:

- To remove the shutter sound, "BEEP" on pg. 46, 48.
- If Snapshot recording is not possible, "PHOTO" blinks when **SNAPSHOT** is pressed.
- If Program AE with special effects ( pg. 38) is engaged, certain modes of Program AE with special effects are disabled during Snapshot recording. In such a case, the icon blinks.
- If **SNAPSHOT** is pressed when "DIS" is set to "ON" ( pg. 47), the Stabilizer will be disabled.
- The Motor Drive mode is disabled when "REC SELECT" is set to " / " in the Menu Screen ( pg. 49).
- If "REC SELECT" is set to " / " in the DSC Menu Screen, still images are recorded on the memory card as well (640 x 480 pixels).
- During tape playback as well, all snapshot modes are available when " COPY" is set to "OFF" in the Menu Screen ( pg. 50). However, the shutter sound is not heard.
- During Snapshot recording, the image displayed in the viewfinder may be partially missing. However, there is no effect in the recorded image.
- When a cable is connected to the AV connector, the shutter sound is not heard from the speaker, however it is recorded onto the tape.

There is the sound effect of a shutter closing.

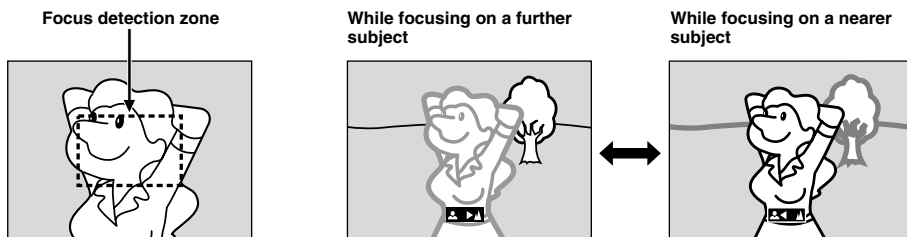

## FEATURE: Auto Focus

### PURPOSE:

The camcorder's Full Range AF system offers continuous shooting ability from close-up (as close as approx. 5 cm (2") to the subject) to infinity.

However, correct focus may not be obtainable in the situations listed below (in these cases use manual focusing):

- When two subjects overlap in the same scene.
- When illumination is low.\*
- When the subject has no contrast (difference in brightness and darkness), such as a flat, one-color wall, or a clear, blue sky.\*
- When a dark object is barely visible in the viewfinder.\*
- When the scene contains minute patterns or identical patterns that are regularly repeated.
- When the scene is affected by sunbeams or light reflecting off the surface of a body of water.
- When shooting a scene with a high-contrast background.

\* The following low-contrast warnings appear blinking: ▲, ◀, ▶ and 👤

### NOTES:

- If the lens is smeared or blurred, accurate focusing is not possible. Keep the lens clean, wiping with a piece of soft cloth if it gets dirty. When condensation occurs, wipe with a soft cloth or wait for it to dry naturally.
- When shooting a subject close to the lens, zoom out first (ⓘ pg. 18). If zoomed-in in the auto focus mode, the camcorder may automatically zoom out depending on the distance between the camcorder and the subject. This will not occur when "TELE MACRO" (ⓘ pg. 48) is activated.

## FEATURE: Manual Focus

### PURPOSE:

To obtain correct focus.

### OPERATION:

- 1) If you are using the viewfinder, you should already have made the necessary viewfinder adjustments (ⓘ pg. 10).
- 2) Set the Power Switch to "MANUAL" while pressing down the Lock Button located on the switch, then press **FOCUS** (ⓘ pgs. 80 and 81, ⓘ FOCUS Button). The manual focus indicator appears.
- 3) To focus on a farther subject, rotate the **MENU/BRIGHT** wheel towards "+". "▶" appears and blinks. To focus on a nearer subject, rotate the **MENU/BRIGHT** wheel towards "-". "◀" appears and blinks.
- 4) Press the **MENU/BRIGHT** wheel in. Focus adjustment is complete.

To reset to Auto Focus, press **FOCUS** twice or set the Power Switch to "AUTO".

If **FOCUS** is pressed once, the camcorder will enter the focus adjustment mode again.

### NOTES:

- Be sure to focus the lens in the maximum telephoto position when you use the Manual Focus mode. If you focus in on a subject in the wide-angle position, sharply focused images cannot be obtained when zoomed up because the depth-of-field is reduced at longer focal lengths.
- When the focus level cannot be adjusted any further or closer, "▲" or "👤" will blink.

## Exposure Control

Manual exposure adjustment is recommended in the following situations:

- When shooting using reverse lighting or when the background is too bright.
- When shooting on a reflective natural background such as at the beach or when skiing.
- When the background is overly dark or the subject light.

**1** Set the Power Switch to “**MANUAL**” while pressing down the Lock Button located on the switch.

**2** Press the **MENU/BRIGHT** wheel in. The Menu Screen appears.

**3** Rotate the **MENU/BRIGHT** wheel to select “**EXPOSURE**”, then press it.

**4** Rotate the **MENU/BRIGHT** wheel to select “**MANUAL**”, then press it. The Menu Screen disappears. The exposure control indicator appears.

**5** Rotate the **MENU/BRIGHT** wheel towards “+” to brighten the image, or towards “-” to darken the image. (maximum ±6)

**6** Press the **MENU/BRIGHT** wheel in. Exposure adjustment is complete.

### To Return To Automatic Exposure Control . . .

..... select “**AUTO**” in step 4. Or, set the Power Switch to “**AUTO**”.

### To Brighten The Subject Quickly . . .

..... press **BACKLIGHT**. **+** is displayed and the subject is brightened. If pressed again, **+** disappears and the brightness returns to the previous level.

- +3 exposure has the same effect as the **BACKLIGHT** Button.
- Using **BACKLIGHT** may cause the light around the subject to become too bright and the subject to become white.
- Backlight compensations is also available when the Power Switch is set to “**AUTO**”.

### NOTE:

You cannot use the manual exposure control at the same time with backlight, spotlight ( pg. 39) compensation and “**SNOW**” ( pg. 39).

## Iris Lock

Use this function in the following situations:

- When shooting a moving subject.
- When the distance to the subject changes (so its size in the LCD monitor or the viewfinder changes), such as when the subject is backing away.
- When shooting on a reflective natural background such as at the beach or when skiing.
- When shooting objects under a spotlight.
- When zooming.

When the subject is close, keep the iris locked. Even when the subject moves away from you, the image will not darken or brighten.

**Before the following steps, perform steps 1 through 4 of “Exposure Control”.**

**5** Adjust zoom so that the subject fills the LCD monitor or the viewfinder, then press and hold the **MENU/BRIGHT** wheel for over 2 seconds. The exposure control indicator and “**I**” appear. Press the **MENU/BRIGHT** wheel in. “**I**” changes to “**□**” and the iris is locked.



Iris lock indicator

BACKLIGHT Button (■)

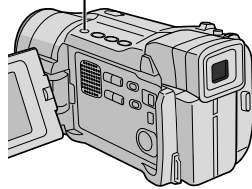

MENU/BRIGHT Wheel

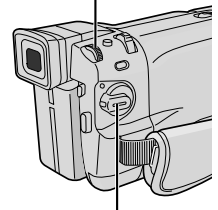

Power Switch

### To Return To Automatic Iris Control . . .

..... rotate **MENU/BRIGHT** to display “**AUTO**” then press it in step 4. The exposure control indicator and “**I**” disappears. Or, set the Power switch to “**AUTO**”.

### To Lock The Exposure Control And The Iris . . .

..... after step 4 of “Exposure Control”, adjust the exposure rotating the **MENU/BRIGHT** wheel. Then lock the iris in step 5 of “Iris Lock”. For automatic locking, rotate the **MENU/BRIGHT** wheel to select “**AUTO**”, then press it in step 4. The iris becomes automatic after about 2 seconds.

### Iris

Like the pupil of the human eye, it contracts in well-lit environments to keep too much light from entering, and dilates in dim environments to allow in more light.

## White Balance Adjustment

A term that refers to the correctness of color reproduction under various lighting. If the white balance is correct, all other colors will be accurately reproduced.

The white balance is usually adjusted automatically. However, more advanced camcorder operators control this function manually to achieve a more professional color/tint reproduction.

**1** Set the Power Switch to “**MANUAL**” while pressing down the Lock Button located on the switch.

**2** Press the **MENU/BRIGHT** wheel in. The Menu Screen appears.

**3** Rotate the **MENU/BRIGHT** wheel to select “**W.BALANCE**”, then press it. The **W.BALANCE** Menu appears.

**4** Rotate the **MENU/BRIGHT** wheel to select the desired mode.

“**AUTO**” ..... White balance is adjusted automatically (factory preset).

“**MWB**” ..... White balance is set manually.

“**FINE**” ..... Outdoors on a sunny day.

“**CLOUD**” ..... Outdoors on a cloudy day.

“**HALOGEN**” ... A video light or similar type of lighting is used.

**5** Press the **MENU/BRIGHT** wheel in. Selection is complete. Press the **MENU/BRIGHT** wheel in again. The Menu Screen closes and the selected mode indicator except “**AUTO**” appears.

### To Return To Automatic White Balance . . .

..... select “**AUTO**” in step 4. Or, set the Power Switch to “**AUTO**”.

### NOTE:



White balance cannot be used when Sepia or Monotone (pg. 39) is activated.

## Manual White Balance Operation

Perform Manual White Balance when shooting under various types of lighting.

**1** Follow steps 1 through 4 of the white balance adjustment, and select “**MWB**”.

**2** Hold a sheet of plain white paper in front of the subject. Adjust zoom or position yourself so that the white paper fills the screen.

**3** Press the **MENU/BRIGHT** wheel in until  begins blinking rapidly. When the setting is completed,  resumes normal blinking.

**4** Press the **MENU/BRIGHT** wheel in twice. The Menu Screen closes and the Manual White Balance indicator  is displayed.

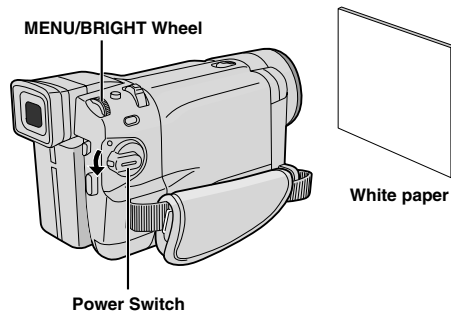

### NOTES:

- In step 2, it may be difficult to focus on the white paper. In such a case, adjust focus manually (pg. 43).
- A subject can be shot under various types of lighting conditions indoors (natural, fluorescent, candlelight, etc.). Because the color temperature is different depending on the light source, the subject tint will differ depending on the white balance settings. Use this function for a more natural result.
- Once you adjust white balance manually, the setting is retained even if the power is turned off or the battery removed.

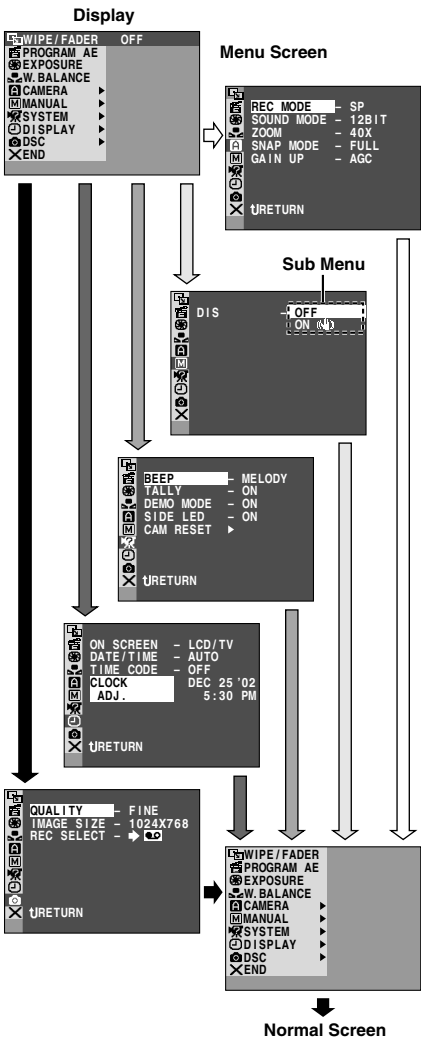
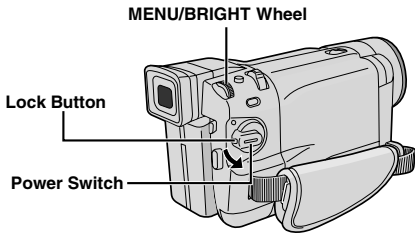

### For Recording Menu

This camcorder is equipped with an easy-to-use, on-screen menu system that simplifies many of the more detailed camcorder settings (pg. 47 – 49).

- 1 Set the Power Switch to “MANUAL” while pressing down the Lock Button located on the switch.
- 2 Press the MENU/BRIGHT wheel in. The Menu Screen appears.
- 3 Rotate the MENU/BRIGHT wheel to select the desired function menu, and press it. The selected function menu appears.
- 4 Function menu setting depends on the function.

If you have selected “WIPE/FADER”, “PROGRAM AE”, “EXPOSURE” or “W. BALANCE” ... see pg. 47.

If you have selected “CAMERA”, “MANUAL”, “SYSTEM”, “DISPLAY” or “DSC” ... go to step 5.









5 Rotate the MENU/BRIGHT wheel to select the desired function and press it. The Sub Menu appears. Then, rotate the MENU/BRIGHT wheel to select the parameter, and press it. Selection is complete.

6 Rotate the MENU/BRIGHT wheel to select “RETURN” and press it twice. The Menu Screen closes.  
• The X icon represents “END”.

#### NOTE:

When the Menu Screen is left on for a couple of minutes, a residual image may be left on the screen and it may take several seconds for the residual image to disappear. This is not due to any defect of the unit.

## Menu Screen Explanations

	<b>WIPE/FADER</b>	Refer to “Fade/Wipe Effects” (☞ pg. 40, 41).	
	<b>PROGRAM AE</b>	Refer to “Program AE With Special Effects” (☞ pg. 38, 39).	
	<b>EXPOSURE</b>	Refer to “Exposure Control” and “Iris Lock” (☞ pg. 44).	
	<b>W.BALANCE</b>	Refer to “White Balance Adjustment” and “Manual White Balance Operation” (☞ pg. 45).	
<b>CAMERA</b>	<b>REC MODE</b>	Allows you to set the tape recording mode (SP or LP) depending on your preference (☞ pg. 13).	
	<b>SOUND MODE</b>	<b>12BIT</b>	Enables tape recording of stereo sound on four separate channels, and is recommended for use when performing audio dubbing. (Equivalent to the 32 kHz mode of previous models)
		<b>16BIT</b>	Enables tape recording of stereo sound on two separate channels. (Equivalent to the 48 kHz mode of previous models)
	<b>ZOOM</b>	<b>10X</b>	When set to “10X” while using digital zoom, the zoom magnification will reset to 10X since digital zoom will be disengaged.
		<b>40X</b>	Allows you to use the Digital Zoom. By digitally processing and magnifying images, zooming is possible from 10X (the optical zoom limit), to a maximum of 40X digital magnification.
		<b>700X</b>	Allows you to use the Digital Zoom. By digitally processing and magnifying images, zooming is possible from 10X (the optical zoom limit), to a maximum of 700X digital magnification.
	<b>SNAP MODE</b>	Refer to “Snapshot (For Tape Recording)” (☞ pg. 42).	
	<b>GAIN UP</b>	<b>OFF</b>	Allows you to shoot dark scenes with no picture brightness adjustment.
		<b>AGC</b>	The overall appearance may be grainy, but the image is bright.
<b>AUTO</b> 		The shutter speed is automatically adjusted (1/30 — 1/200 sec.). Shooting a subject in low or poor lighting at 1/30 sec. shutter speed provides a brighter image than in the AGC mode, but the subject’s movements are not smooth or natural. The overall appearance may be grainy. While the shutter speed is being automatically adjusted, “  A” is displayed.	
<b>MANUAL</b>	<b>DIS</b>	<b>OFF</b>	To compensate for unstable images caused by camera-shake, particularly at high magnification.  <b>NOTES:</b> <ul style="list-style-type: none"> <li>• Accurate stabilization may not be possible if hand shake is excessive, or under the following conditions: <ul style="list-style-type: none"> <li>• When shooting subjects with vertical or horizontal stripes.</li> <li>• When shooting dark or dim subjects.</li> <li>• When shooting subjects with excessive backlighting.</li> <li>• When shooting scenes with movement in various directions.</li> <li>• When shooting scenes with low-contrast backgrounds.</li> </ul> </li> <li>• Switch off this mode when recording with the camcorder on a tripod.</li> <li>• The “” indicator blinks or goes out if the Stabilizer cannot be used.</li> </ul>
		<b>ON</b> 	

 : Factory-preset

**NOTES:**

- Settings made in the “**CAMERA**” Menu remain effective whether the Power Switch is set to “**AUTO**” or “**MANUAL**”. However, the menu settings can be changed only when the Power Switch is set to “**MANUAL**”.
- The “**MANUAL**” settings are effective only when the Power Switch is set to “**MANUAL**”.

CONTINUED ON NEXT PAGE

## Menu Screen Explanations (cont.)



MANUAL	TELE MACRO	OFF	Usually the distance to a subject where the lens is in focus depends on the zoom magnification. Unless there is a distance more than 1m (3.3 ft.) to the subject, the lens is out of focus at the maximum telephoto setting. When set to "ON", you can shoot a subject as large as possible at a distance of approx. 60 cm (2 ft.). • Depending on the zoom position, the lens may go out of focus.	
		ON		
	WIDE MODE	OFF	Records with no change in the screen ratio. For playback on a TV with a normal screen ratio.	
		CINEMA <input type="checkbox"/>	Inserts black bands at the top and bottom of the screen. During playback on wide-screen TVs, the black bands at the top and bottom of the screen are cut and the screen ratio becomes 16:9. <input type="checkbox"/> appears. When using this mode, refer to your wide-screen TV's instruction manual. During playback/recording on 4:3 TVs/LCD monitor/viewfinder, black bands are inserted at the top and bottom of the screen and the image appears like a letterboxed 16:9 movie. • The "CINEMA" mode is effective only when the VIDEO/MEMORY Switch is set to "VIDEO".	
		SQUEEZE <input checked="" type="checkbox"/>	For playback on TVs with an aspect ratio of 16:9. Naturally expands the image to fit the screen without distortion. <input checked="" type="checkbox"/> appears. When using this mode, refer to your wide-screen TV's instruction manual. During playback/recording on 4:3 TVs/LCD monitor/viewfinder, the image is elongated vertically. • The "SQUEEZE" mode is effective only when the VIDEO/MEMORY Switch is set to "VIDEO".	
		S.WIDE <input checked="" type="checkbox"/>	" <input checked="" type="checkbox"/>	
	WIND CUT	OFF	Disengages the function which cuts down on noise created by wind.	
		ON <input checked="" type="checkbox"/>	Helps cut down on noise created by wind. " <input checked="" type="checkbox"/>	
	SYSTEM	BEEP	OFF	Even though not heard while shooting, shutter sound is recorded on the tape.
			BEEP	The beep sounds when the power is turned on or off, and at the beginning and end of recording. Also to activate the shutter sound effect ( <input checked="" type="checkbox"/> pg. 26, 42).
MELODY			Instead of a beep, a melody sounds when any operation is performed. It also activates the shutter sound effect ( <input checked="" type="checkbox"/> pg. 26, 42).	
TALLY		OFF	The tally lamp remains off at all times.	
		ON	The tally lamp comes on to signal the start of recording.	

: Factory-preset

## NOTES:

- The " MANUAL" settings are effective only when the Power Switch is set to " MANUAL".
- " SYSTEM" functions which are set when the Power Switch is set to " MANUAL" are also applied when the Power Switch is set to "PLAY" ( pg. 50).



<b>SYSTEM</b>	<b>DEMO MODE</b>	<b>OFF</b>	Automatic demonstration will not take place.
		<b>ON</b>	Demonstrates certain functions such as Program AE with special effects, etc., and can be used to confirm how these functions operate. Demonstration starts in the following cases: <ul style="list-style-type: none"> <li>• When the Menu Screen is closed after "DEMO MODE" is turned "ON".</li> <li>• With "DEMO MODE" set to "ON", if there is no operation for about 3 minutes after the Power Switch is set to "<b>AUTO</b>" or "<b>MANUAL</b>".</li> </ul> Performing any operation during the demonstration stops the demonstration temporarily. If no operation is performed for more than 3 minutes after that, the demonstration will resume. <p><b>NOTES:</b></p> <ul style="list-style-type: none"> <li>• If a tape is in the camcorder, the demonstration cannot be turned on.</li> <li>• "DEMO MODE" remains "ON" even if the camcorder power is turned off.</li> <li>• If "DEMO MODE" remains "ON", some functions will not be available. After viewing demo, set to "OFF".</li> </ul>
	<b>SIDE LED</b>	<b>ON</b>	The Side LED indicator (☞ p. 80, 81) lights on the camcorder when the Power Switch is set to " <b>AUTO</b> " or " <b>MANUAL</b> ".
		<b>OFF</b>	
	<b>CAM RESET</b>	<b>CANCEL</b>	Does not reset all settings to the factory-preset.
<b>EXECUTE</b>		Resets all settings to the factory-preset.	
<b>DISPLAY</b>	<b>ON SCREEN</b>	<b>LCD</b>	Keeps the camcorder's display (except the date, time and time code) from appearing on the connected TV screen.
		<b>LCD/TV</b>	Makes the camcorder's display appear on screen when the camcorder is connected to a TV.
	<b>DATE/TIME</b>	<b>OFF</b>	The date/time does not appear.
		<b>AUTO</b>	Displays the date/time for approx. 5 seconds in the following cases: <ul style="list-style-type: none"> <li>• When the Power Switch is set from "OFF" to "<b>AUTO</b>" or "<b>MANUAL</b>".</li> <li>• When tape playback starts. The camcorder displays the date/time when scenes are recorded.</li> <li>• When the date is changed during tape playback.</li> </ul>
		<b>ON</b>	The date/time is always displayed.
	<b>TIME CODE</b>	<b>OFF</b>	Time code is not displayed.
		<b>ON</b>	Time code is displayed on the camcorder and on the connected TV. Frame numbers are not displayed during recording.
<b>CLOCK ADJ.</b>		Allows you to set the current date and time (☞ pg. 11).	
<b>DSC</b>	<b>QUALITY</b>	Refer to "Picture Quality/Image Size Setting" (☞ pg. 14).	
	<b>IMAGE SIZE</b>		
	<b>REC SELECT</b>	➔ 	When Snapshot recording is performed with the <b>VIDEO/MEMORY</b> Switch set to "VIDEO", still images are recorded only onto the tape.
		➔  / ➔ 	When Snapshot recording is performed with the <b>VIDEO/MEMORY</b> Switch set to "VIDEO", still images are recorded not only onto the tape but also on the memory card (640 x 480 pixels). In this mode, the "SNAP MODE" selection in the CAMERA Menu is also applicable to memory card recording.

 : Factory-preset

### NOTES:

- "SYSTEM" and "DISPLAY" functions which are set when the Power Switch is set to "**MANUAL**" are also applied when the Power Switch is set to "PLAY" (☞ pg. 50). "CLOCK ADJ." only appears when the Power Switch is set to "**MANUAL**".
- Settings made in the "DISPLAY" Menu remain effective even when the Power Switch is set to "**AUTO**". However, the menu settings can be changed only when the Power Switch is set to "**MANUAL**".
- The date indication can also be turned on/off by pressing the **DISPLAY** Button on the remote control (☞ pg. 23, 52, 59).

**VIDEO/MEMORY Switch**  
(Open the LCD monitor to access this switch.)

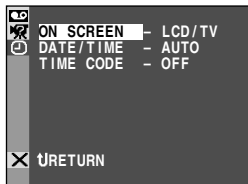
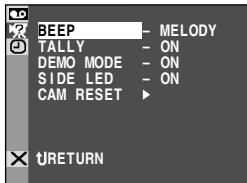
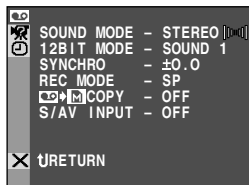
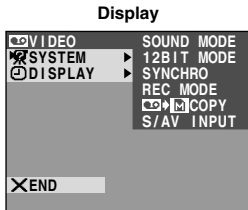
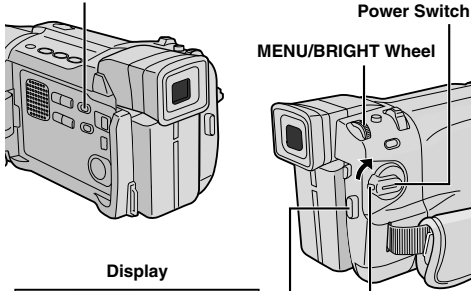

### For Playback Menu

The following procedure applies to all except Synchro Comp (☞ pg. 62).

- 1** Set the **VIDEO/MEMORY** Switch to "VIDEO", then set the Power Switch to "PLAY" while pressing down the Lock Button located on the switch.
- 2** Press the **MENU/BRIGHT** wheel in. The Menu Screen appears.
- 3** Rotate the **MENU/BRIGHT** wheel to select the desired function menu, and press it. The selected function menu appears.
- 4** Rotate the **MENU/BRIGHT** wheel to select the desired function, and press it to display the Sub Menu.
- 5** Rotate the **MENU/BRIGHT** wheel to select the desired parameter and press it. Selection is complete.
- 6** Rotate the **MENU/BRIGHT** wheel to select "RETURN" and press it twice to close the Menu Screen.

### Menu Screen Explanations



VIDEO	SOUND MODE	☞ pg. 51.
	12BIT MODE	☞ pg. 51.
	SYNCHRO	☞ pg. 62.
	REC MODE	Allows you to set the tape recording mode (SP or LP) depending on your preference (☞ pg. 13). It is recommended you use "REC MODE" in the "VIDEO" Menu when using this camcorder as a recorder during dubbing (☞ pg. 52, 53).
VIDEO	COPY	<b>ON:</b> Enables dubbing of images recorded on a tape to a memory card (☞ pg. 32). <b>OFF:</b> Enables snapshots to be taken during tape playback.
	S/AV INPUT	<b>ON:</b> Enables audio/video signal input from the AV and S-VIDEO connectors (☞ pg. 52). <b>OFF:</b> Enables audio/video signal output to a TV, VCR, etc. via the AV and S-VIDEO connectors (☞ pg. 22, 52).
SYSTEM	Each setting is linked with "DISPLAY" or "SYSTEM", which appears when the Power Switch is set to "MANUAL" (☞ pg. 48, 49). The parameters are the same as in the description on pg. 48, 49.	
DISPLAY		

### NOTES:

- The date indication can also be turned on/off by pressing **DISPLAY** on the remote control.
- "REC MODE" can be set when the Power Switch is set to "PLAY" or "MANUAL" (☞ pg. 13, 47).
- When "S/AV INPUT" is set to "ON", camcorder playback cannot be viewed on the AV output.

## Playback Sound

During tape playback, the camcorder detects the sound mode in which the recording was made, and plays the sound back. Select the type of sound to accompany your playback picture. According to the menu access explanation on pg. 50, select "SOUND MODE" or "12BIT MODE" from the Menu Screen and set it to the desired parameter.



SOUND MODE	STEREO 	Sound is output on both "L" and "R" channels in stereo.
	SOUND L 	Sound from the "L" channel is output in stereo.
	SOUND R 	Sound from the "R" channel is output in stereo.
12BIT MODE	MIX	Original and dubbed sounds are combined and output in stereo on both "L" and "R" channels in stereo.
	SOUND 1	Original sound is output on both "L" and "R" channels in stereo.
	SOUND 2	Dubbed sound is output on both "L" and "R" channels in stereo.

 : Factory-preset

### NOTES:

- The "SOUND MODE" setting is available for both 12-bit and 16-bit sound. (In previous models' functions, "12-bit" is called "32 kHz" and "16-bit" is called "48 kHz".)
- The camcorder cannot detect the sound mode in which the recording was made during fast-forward or rewind. During playback the sound mode is displayed in the upper left corner.

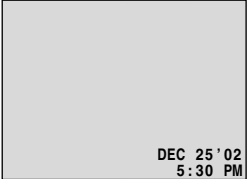
## Display

<p><b>ON SCREEN setting:</b> For playback sound, tape speed and tape running.</p> 	<p><b>DATE/TIME setting:</b> For date/time.</p> 	<p><b>TIME CODE setting:</b> For time code.</p>  <p>Minutes Seconds Frames*</p> <p>*30 frames = 1 second</p>
--	--	--

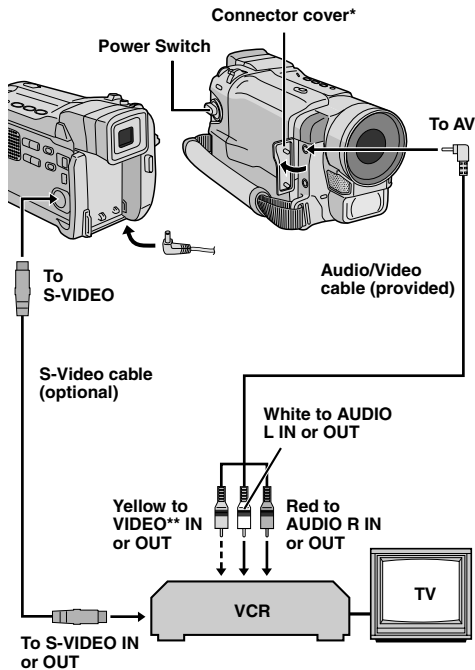

\* When connecting the cables, open this cover.

\*\* Connect when an S-Video cable is not used.

### To Use This Camcorder As A Recorder . . .

1. Set the **VIDEO/MEMORY** Switch to "VIDEO", then set the camcorder's Power Switch to "PLAY" while pressing down the Lock Button located on the switch.
2. Set "S/AV INPUT" to "ON" and set "REC MODE" to "SP" or "LP" (ⓘ pg. 50).
3. Connect the cables as shown in the illustration and load a cassette to record on.
4. Press the Recording Start/Stop button to engage the Record-Pause mode. "AV. IN" appears on the screen.
5. Press the Recording Start/Stop button to start recording. ⏪ rotates.
6. Press the Recording Start/Stop button again to engage the Record-Pause mode. ⏪ stops rotating.

### NOTES:

- After dubbing, set "S/AV INPUT" back to "OFF".
- Analog signals can be converted to digital signals with this procedure.
- It is also possible to dub from another camcorder.

## Dubbing To Or From A VCR

- 1 Following the illustration, connect the camcorder and the VCR. Also refer to pg. 22 and 23.
- 2 Set the **VIDEO/MEMORY** Switch to "VIDEO", then set the camcorder's Power Switch to "PLAY" while pressing down the Lock Button located on the switch, turn on the VCR's power, and insert the appropriate cassettes in the camcorder and the VCR.
- 3 Engage the VCR's AUX and Record-Pause modes.
- 4 Engage the camcorder's Play mode to find a spot just before the edit-in point. Once it is reached, press ▶/|| on the camcorder.
- 5 Press ▶/|| on the camcorder and engage the VCR's Record mode.
- 6 Engage the VCR's Record-Pause mode and press ▶/|| on the camcorder.
- 7 Repeat steps 4 through 6 for additional editing, then stop the VCR and camcorder when finished.

### NOTES:

- As the camcorder starts to play your footage it will appear on your TV. This will confirm the connections and the AUX channel for dubbing purposes.
- Before you start dubbing, make sure that the indications do not appear on the connected TV. If they do, they are being recorded onto the new tape.

### To choose whether or not the following displays appear on the connected TV . . .

- Date/Time  
..... set "DATE/TIME" to "AUTO", "ON" or "OFF" in the Menu Screen (ⓘ pg. 50).  
Or, press **DISPLAY** on the remote control to turn on/off the date indication.
- Time Code  
..... set "TIME CODE" to "ON" or "OFF" in the Menu Screen (ⓘ pg. 50).
- Playback Sound Mode, Tape Speed And Tape Running Displays  
..... set "ON SCREEN" to "LCD" or "LCD/TV" in the Menu Screen (ⓘ pg. 50).
- **The S-Video cable is optional. Be sure to use the YTU94146A S-Video cable. Consult the JVC Service Center described on the sheet included in the package for details on its availability. Make sure to connect the end with a core filter to the camcorder. The core filter reduces interference.**

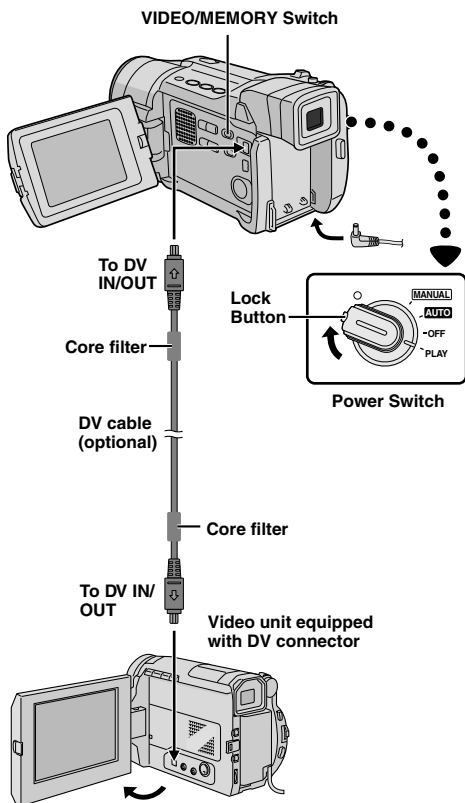

## Dubbing To Or From A Video Unit Equipped With A DV Connector (Digital Dubbing)

It is also possible to copy recorded scenes from this camcorder onto another video unit equipped with a DV connector. Since a digital signal is sent, there is little if any image or sound deterioration.

### [To use this camcorder as a player]

- 1 Make sure all units are turned off. Connect this camcorder to a video unit equipped with a DV input connector using a DV cable as shown in the illustration.
- 2 Set this camcorder's **VIDEO/MEMORY** Switch to "VIDEO", then the Power Switch to "PLAY" while pressing down the Lock Button located on the switch, turn on the video unit's power, and insert the appropriate cassettes in this camcorder and the video unit.
- 3 Press ► to play back the source tape.
- 4 While watching the playback on the monitor, engage the DV connector-equipped video unit's record mode from the spot on the source tape you want to begin recording.

### NOTES:

- It is recommended to use the AC Adapter as the power supply instead of the battery pack (☞ pg. 9).
- If the remote control is used when both the player and recorder are JVC video units, both units will perform the same operation. To prevent this from happening, press the buttons on both units.
- If a blank portion or disturbed image is played back on the player during dubbing, the dubbing may stop so that an unusual image is not dubbed.
- Even though the DV cable is connected correctly, sometimes the image may not appear in step 4. If this occurs, turn off the power and make connections again.
- If "Playback Zoom" (☞ pg. 57), "Playback Special Effects" (☞ pg. 56) or "Snapshot" is attempted during playback, only the original playback image recorded on the tape is output from the DV IN/OUT connector.
- When using a DV cable, be sure to use the optional JVC VC-VDV204U DV cable.

### [To Use This Camcorder As A Recorder]

1. Set this camcorder's **VIDEO/MEMORY** Switch to "VIDEO", then the Power Switch to "PLAY" while pressing down the Lock Button located on the switch.
2. Set "REC MODE" to "SP" or "LP" in the Menu Screen (☞ pg. 50).
3. Connect the DV cable as shown in the illustration and load a cassette to record on.
4. Press the Recording Start/Stop button to engage the Record-Pause mode. "DV.IN" appears on the screen.
5. Press the Recording Start/Stop button to start recording. ⏻ rotates.
6. Press the Recording Start/Stop button again to engage the Record-Pause mode. ⏻ stops rotating.

### NOTES:

- Digital Dubbing is performed in the sound mode recorded on the original tape, regardless of the current "SOUND MODE" setting (☞ pg. 47).
- During Digital Dubbing, no signals are output from the video or audio connectors.

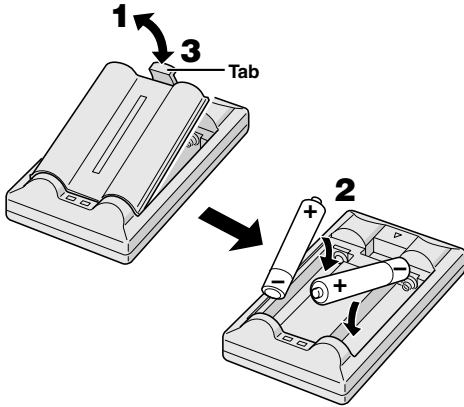

The Full-Function Remote Control Unit can operate this camcorder from a distance as well as the basic operations (Playback, Stop, Pause, Fast-Forward and Rewind) of your VCR. It also makes additional playback functions possible.

### Installing The Batteries

The remote control uses two "AAA (R03)" size batteries. See "General Battery Precautions" (📖 pg. 75).

- 1** Open the battery compartment cover as illustrated.
- 2** Insert two "AAA (R03)" size batteries in the correct direction.
- 3** Replace the battery compartment cover.

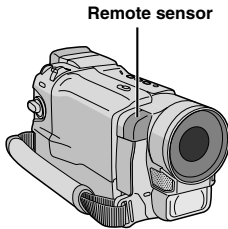

When using the remote control, be sure to point it at the remote sensor. The transmitted beam's approximate effective distance for indoor use is 5m (16ft).

The transmitted beam may not be effective or may cause incorrect operation outdoors or when the remote sensor is directly exposed to sunlight or powerful lighting.

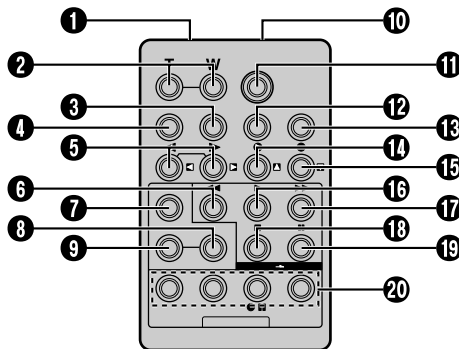

Buttons	Functions	
	With the camcorder's Power Switch set to the camera position ("AUTO" or "MANUAL").	With the camcorder's Power Switch set to "PLAY".
1 Infrared beam transmitting window	Transmits the beam signal.	
2 Zoom (T/W) Buttons	Zoom in/out (☞ pg. 18)	Zoom in/out (☞ pg. 57)
3 DISPLAY Button	—	☞ pg. 23, 52, 59
4 SHIFT Button	—	☞ pg. 57, 58
5 SLOW Rewind/Forward Buttons Left/Right Buttons	— —	☞ pg. 56 ☞ pg. 57
6 REW Button	—	<ul style="list-style-type: none"> <li>• Rewind/Reverse Shuttle Search on the tape (☞ pg. 21)</li> <li>• Displays previous page/file on the memory card (☞ pg. 28)</li> </ul>
7 FADE/WIPE Button	—	☞ pg. 60
8 EFFECT ON/OFF Button	—	☞ pg. 56
9 EFFECT Button	—	☞ pg. 56
10 PAUSE IN Connector	—	☞ pg. 59
11 START/STOP Button	Functions the same as the Recording Start/Stop Button on the camcorder.	
12 MBR SET Button	—	☞ pg. 58
13 SNAPSHOT Button	Functions the same as SNAPSHOT on the camcorder.	
14 Up Button INSERT Button	— —	☞ pg. 57 ☞ pg. 64
15 Down Button A. DUB Button	— —	☞ pg. 57 ☞ pg. 63
16 PLAY Button	—	<ul style="list-style-type: none"> <li>• Starts Playback of the tape (☞ pg. 21)</li> <li>• Starts Auto Playback of the memory card (☞ pg. 28)</li> </ul>
17 FF Button	—	<ul style="list-style-type: none"> <li>• Forward/Forward Shuttle Search on the tape (☞ pg. 21)</li> <li>• Displays next page/file on the memory card (☞ pg. 28)</li> </ul>
18 STOP Button	—	<ul style="list-style-type: none"> <li>• Stops the tape (☞ pg. 21)</li> <li>• Stops Auto Playback (☞ pg. 28)</li> </ul>
19 PAUSE Button	—	Pauses the tape (☞ pg. 56)
20 R.A.EDIT Buttons	—	☞ pg. 58 – 62

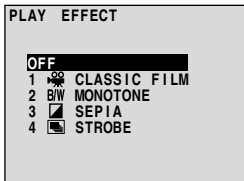
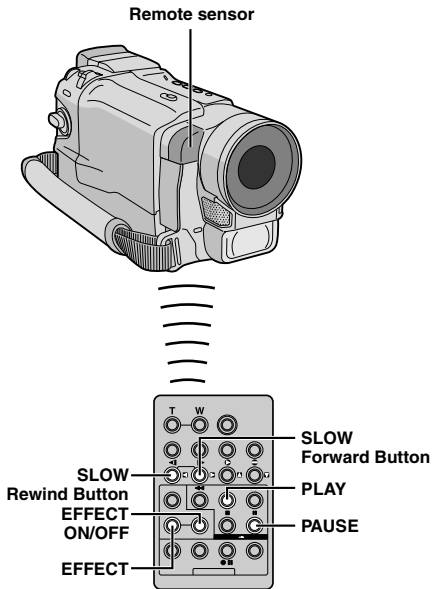

PLAY EFFECT Select Menu

### FEATURE: Slow-Motion Playback

#### PURPOSE:

To allow slow-speed search in either direction during tape playback.

#### OPERATION:

- 1) To change from normal to Slow-Motion Playback, press **SLOW** (◀ or ▶) more than approx. 2 seconds. After approx. 1 minute in Slow Rewind or approx. 2 minutes in Slow Forward, normal playback resumes.
  - To stop Slow-Motion Playback, press **PLAY** (▶).

#### NOTES:

- You can also engage Slow-Motion Playback from Still Playback by pressing **SLOW** more than approx. 2 seconds.
- During Slow-Motion Playback, due to digital image processing, the picture may take on a mosaic effect.
- After **SLOW** (◀ or ▶) is pressed and held, the still image may be displayed for a few seconds, followed by a blue screen for a few seconds. This is not a malfunction.
- There may be a small margin between the slow-motion playback start point you chose and the actual start point for Slow-Motion Playback.
- During Slow-Motion Playback, there will be disturbances in video and the picture may seem unstable, especially with steady images. This is not a malfunction.
- During Slow-Motion Playback, press **PAUSE** (||) to pause playback.

### FEATURE: Frame-By-Frame Playback

#### PURPOSE:

To allow frame-by-frame search during tape playback.

#### OPERATION:

- 1) To change from normal to Frame-By-Frame Playback, press **SLOW** (▶) repeatedly for forward or **SLOW** (◀) repeatedly for reverse. Each time it is pressed, the frame is played back.

#### NOTE:

You can also engage Frame-By-Frame Playback from Still Playback by pressing **SLOW** (◀ or ▶) repeatedly.

### FEATURE: Playback Special Effects

#### PURPOSE:

To allow you to add creative effects to the playback image.

#### OPERATION:

- 1) To start playback, press **PLAY** (▶).
- 2) Point the remote control at the camcorder's remote sensor and press **EFFECT**. The PLAY EFFECT Select Menu appears.
- 3) Move the highlight bar to the desired effect by pressing **EFFECT**. The selected function is activated and after 2 seconds the menu disappears.
  - To deactivate the selected effect, press **EFFECT ON/OFF** on the remote control. Pressing it again re-activates the selected effect.
  - To change the selected effect, repeat from step 2 above.

#### NOTE:

The effects that can be used during playback are Classic Film, Monotone, Sepia and Strobe. The effects work the same in playback as they did in recording. Refer to page 39 for more information.



Remote sensor

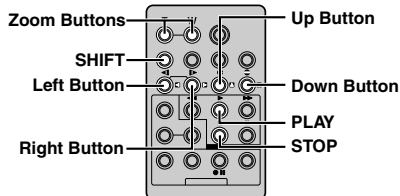
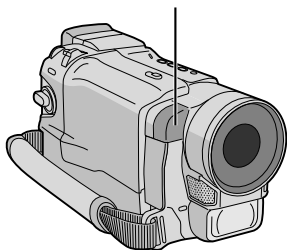

## FEATURE: Playback Zoom

### PURPOSE:

To magnify the recorded image up to 70X at any time during playback.

### OPERATION:

- 1) Press **PLAY** (▶) to find the scene of interest.
- 2) Press the Zoom Buttons (**T/W**) on the remote control. Make sure the remote control is pointed at the camcorder's remote sensor. Pressing **T** zooms in.
- 3) You can move the image on screen around to find a particular portion of the picture. While holding down **SHIFT**, press ◀ (**Left**), ▶ (**Right**), ▲ (**Up**) and ▼ (**Down**).
  - To end zoom, press and hold **W** until magnification returns to normal. Or, press **STOP** (■) and then press **PLAY** (▶).

### NOTES:

- Zoom can also be used during slow-motion and still playback.
- Due to digital image processing, the quality of the image may suffer.



Normal playback

To move image, press ▶ (Right) while keeping SHIFT held down.



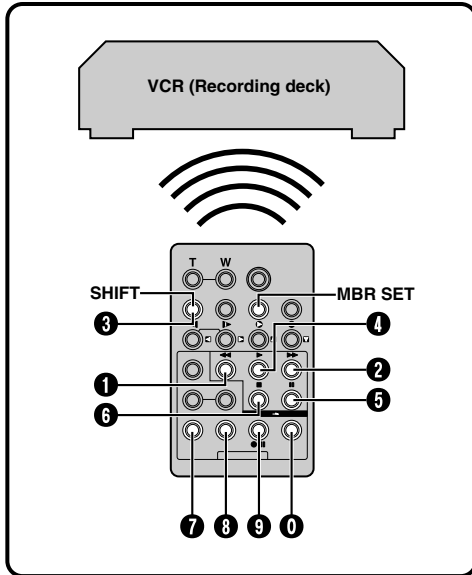

## Random Assemble Editing [R.A.Edit]

Create edited videos easily using your camcorder as the source player. You can select up to 8 "cuts" for automatic editing, in any order you like. R.A.Edit is more easily performed when the MBR (Multi-Brand Remote) is set to operate with your brand of VCR (see VCR CODE LIST), but can also be performed by operating the VCR manually.

Before operation, make sure the batteries are installed in the remote control (☞ pg. 54).

### SET REMOTE/VCR CODE

**1** Turn off the power to the VCR and point the remote towards the VCR's infrared sensor. Then, referring to the VCR CODE LIST, press and hold **MBR SET**, and enter the brand code. The code is automatically set once you release **MBR SET**, and the VCR's power comes on.

**2** Make sure the VCR's power is on. Then, while holding **SHIFT**, press the button on the remote for the desired function. The functions the remote can control are PLAY, STOP, PAUSE, FF, REW and VCR REC STBY (you do not need to press **SHIFT** for this one).

You are now ready to try Random Assemble Editing.

### IMPORTANT

**Although the MBR is compatible with JVC VCRs and those of many other makers, it may not work with yours or may offer limited functions.**

### NOTES:

- If the VCR's power does not come on in step 1, try another code from the VCR CODE LIST.
- Some brands of VCR do not come on automatically. In this case, turn the power on manually and try step 2.
- If the remote control is not able to control the VCR, use the controls on the VCR.
- When the remote control's batteries run out, the VCR brand you have set will be erased. In that case, replace the old battery with a new one to reset the VCR brand.

### VCR CODE LIST

VCR BRAND NAME	BRAND CODE	VCR BRAND NAME	BRAND CODE
GE	1 1	PHILIPS	3 3
	9 2		7 2
	9 0	PANASONIC	1 3
	9 4		1 7
HITACHI	6 6		1 1
	6 3		9 4
JVC A B C	9 1	1 8	RCA
	9 6	9 2	
	9 3	9 4	
MAGNAVOX	9 5	6 6	SANYO
	1 1	6 3	
	7 1	9 0	
	7 6	3 6	
MITSUBISHI	6 7	3 5	SHARP
	6 8	1 5	
NEC	3 7	1 0	SONY
	3 8	6 5	
PHILIPS	1 9	6 0	
	9 5	3 9	
	1 1	3 1	
	9 4	TOSHIBA	
	9 1		6 9
	9 6		6 1
1 2	ZENITH	1 6	

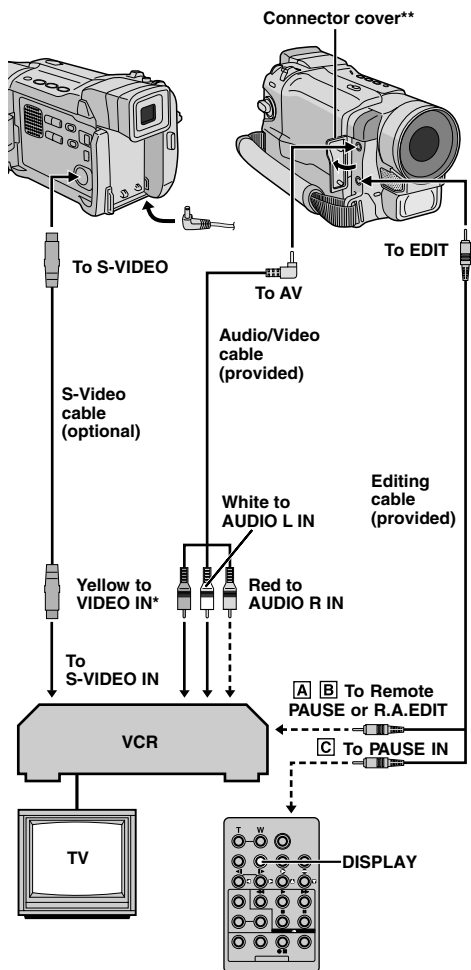

\* Connect when an S-Video cable is not used.

\*\* When connecting cables, open this cover.

## MAKE CONNECTIONS

Also refer to pg. 22 and 23.

### 1 **A** A JVC VCR equipped with a remote pause connector . . .

..... connect the editing cable to the Remote PAUSE connector.

### **B** A JVC VCR not equipped with a remote pause connector but equipped with an R.A.EDIT connector . . .

..... connect the editing cable to the R.A.EDIT connector.

### **C** A VCR other than above . . .

..... connect the editing cable to the remote control's PAUSE IN connector.

**2** Insert a recorded tape into the camcorder. Set the VIDEO/MEMORY Switch to "VIDEO", then set the Power Switch to "PLAY" while pressing down the Lock Button located on the switch.

**3** Turn the VCR power on, insert a recordable tape and engage the AUX mode (refer to the VCR's instructions).

### NOTES:

- Before Random Assemble Editing, make sure the indications do not appear on the TV monitor. If they do, they will be recorded onto the new tape.

### To choose whether or not the following displays appear on the connected TV . . .

- Date/Time
  - ..... set "DATE/TIME" to "AUTO", "ON" or "OFF" in the Menu Screen (☞ pg. 50).
  - Or, press **DISPLAY** on the remote control to turn on/off the date indication.
- Time Code
  - ..... set "TIME CODE" to "ON" or "OFF" in the Menu Screen (☞ pg. 50).
- Playback Sound Mode, Tape Speed And Tape Running Displays
  - ..... set "ON SCREEN" to "LCD" or "LCD/TV" in the Menu Screen (☞ pg. 50).
- The S-Video cable is optional. Be sure to use the YTU94146A S-Video cable. Consult the JVC Service Center described on the sheet included in the package for details on its availability. Make sure to connect the end with a core filter to the camcorder. The core filter reduces interference.
- When editing on a VCR equipped with a DV input connector, an optional DV cable can be connected instead of an S-Video cable and audio/video cable.

Program

	IN	OUT	MODE
1	--:--	--:--	
2			
3			
4			
5			
6			
7			
8			
TIME CODE		--:--	
TOTAL		00:00	

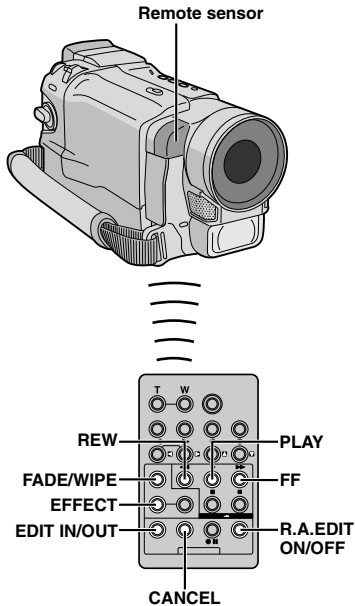
Random Assemble  
Editing Menu

## SELECT SCENES

**4** Point the remote control at the camcorder's remote sensor. Press **PLAY** (▶) and then press **R.A.EDIT ON/OFF** on the remote control. The Random Assemble Editing Menu appears.

**5** If using a Fade/Wipe at the beginning of the scene, press **FADE/WIPE** on the remote control.

- Cycle through the effects by pressing repeatedly, and stop when the one you want is displayed.

**6** At the beginning of the scene, press **EDIT IN/OUT** on the remote control. The Edit-In position appears in the Random Assemble Editing Menu.

**7** At the end of the scene, press **EDIT IN/OUT**. The Edit-Out position appears in the Random Assemble Editing Menu.

**8** If using a Fade/Wipe at the end of the scene, press **FADE/WIPE**.

- Cycle through the effects by pressing repeatedly, and stop when the one you want is displayed.
- If you select a Fade/Wipe effect for an Edit-Out point, the effect is automatically applied to the following Edit-In point.
- When you use Fade/Wipe effects, that time is included in the total time.

**9** If using Playback Special Effects, press **EFFECT** (⏮ pg. 56).

**10** Repeat steps 6 through 9 to register additional scenes.

- To change previously registered points, press **CANCEL** on the remote control. The registered points disappear, one at a time, from the most recently registered point.
- If you are not using Fade/Wipe or Program AE with special effects, repeat steps 6 and 7 only.

## NOTES:

- When choosing a scene, set Edit-In and Edit-Out points so that there is a relatively large difference between them.
- If the search time for an in-point exceeds 5 minutes, the recording deck's Record-Standby mode will be canceled and editing will not take place.
- If there are blank portions before or after the Edit-In and Edit-Out points, a blue screen may be included in the edited version.
- Since time codes register time only as accurately as seconds, the time code total time may not match the total program time exactly.
- Turning off the camcorder's power erases all registered Edit-In and Edit-Out points.
- If you select Sepia or Monotone mode from Program AE with special effects, you cannot use the Black & White Fader. In this case the Black & White indicator begins blinking. Once the next Edit-In point is registered, the effect is turned off. To combine these effects, use Sepia or Monotone during recording, then use the Black & White Fader during Random Assemble Editing.
- It is not possible to use Fade/Wipe effects and Program AE with special effects during Random Assemble Editing using a DV cable.

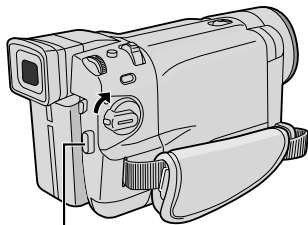

Recording Start/Stop Button

	IN	OUT	MODE
1	00:25	02:05	--
2	07:18	08:31	--
3	03:33	05:53	B/W
4	09:30	13:15	□
5	15:55	16:29	□
6	--	--	--
7	--	--	--
8	--	--	--
TIME CODE		16:30	
TOTAL		9:39	

Random Assemble Editing Menu

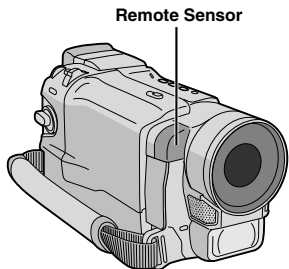

Remote Sensor

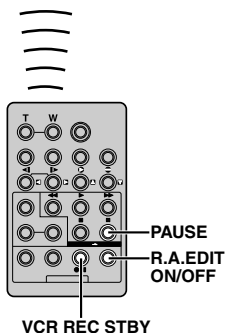

VCR REC STBY

## AUTOMATIC EDITING TO VCR

**11** Rewind the tape in the camcorder to the beginning of the scene you want to edit and press **PAUSE (II)**.

**12** Point the remote control towards the VCR's remote sensor and press **VCR REC STBY (●II)**, or manually engage the VCR's Record-Pause mode.

**13** Press the Recording Start/Stop Button on the camcorder. Editing proceeds as programmed, right through to the end of the last registered scene.

- When dubbing is complete, the camcorder enters the Pause mode, and the VCR enters its Record-Pause mode.
- If you do not register an Edit-Out point, the tape will be dubbed all the way to the end automatically.
- If you operate the camcorder during automatic editing, the VCR will enter its Record-Pause mode and automatic editing will stop.

**14** Engage the Stop modes for the camcorder and the VCR.

To make the R.A.Edit counter display disappear, press **R.A.EDIT ON/OFF** on the remote control.

### NOTES:

- Pressing **R.A.EDIT ON/OFF** on the remote control clears all settings registered during Random Assemble Editing.
- When the editing cable is connected to the remote control's Pause In connector during dubbing, make sure the remote control is pointed at the VCR's sensor, and the path between the two is unobstructed.
- Random Assemble Editing may not function properly when using a tape including several duplicated time codes (see pg. 20).

CONTINUED ON NEXT PAGE

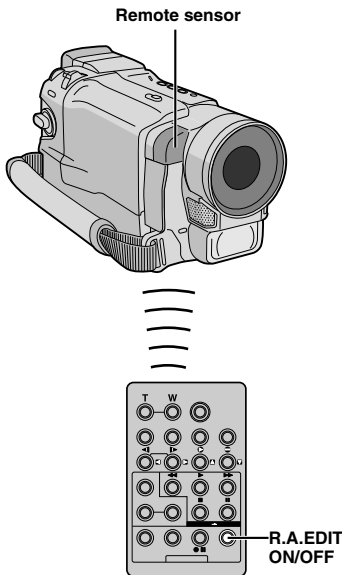
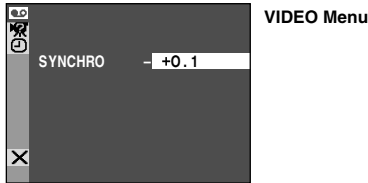
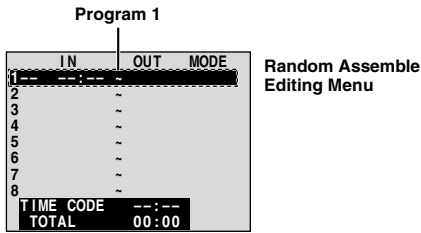

## For More Accurate Editing

Some VCRs make the transition from Record-Pause to Record mode faster than others. Even if you begin editing for the camcorder and the VCR at exactly the same time, you may lose scenes you wanted, or find that you have recorded scenes you did not want. For a cleanly edited tape, confirm and adjust the timing of the camcorder against your VCR.

### DIAGNOSING VCR/CAMCORDER TIMING

- 1 Play back the tape in the camcorder, then point the remote control at the camcorder's remote sensor and press **R.A.EDIT ON/OFF**. The Random Assemble Editing Menu appears.
- 2 Perform Random Assemble Editing on Program 1 only. In order to check VCR and camcorder timing, select the beginning of a scene transition as your Edit-In point.
- 3 Play back the dubbed scene.
  - If any images from the scene prior to the transition you chose for your Edit-In point were recorded, that means your VCR moves too quickly from Record-Pause to Record mode.
  - If the scene you tried to dub starts in progress, the VCR is slow to start recording.

### ADJUSTMENT OF VCR/CAMCORDER TIMING

- 4 Point the remote control at the camcorder's remote sensor and press **R.A.EDIT ON/OFF** to make the Random Assemble Editing menu disappear, then press the **MENU/BRIGHT** wheel in. The Menu Screen appears.
- 5 Rotate the **MENU/BRIGHT** wheel to select "VIDEO" and press it. The VIDEO Menu appears. Then, rotate it to "SYNCHRO" and press it. The value for "SYNCHRO" is highlighted.
- 6 Based on the diagnostics performed, you can now advance the VCR's record timing by rotating the **MENU/BRIGHT** wheel towards "+". You can also delay the VCR's record timing by rotating the **MENU/BRIGHT** wheel towards "-". The adjustment range is from -1.3 to +1.3 seconds, in 0.1-second increments. Press the **MENU/BRIGHT** wheel in to finish the setting.
- 7 Rotate the **MENU/BRIGHT** wheel to select "RETURN" and press it twice. Now perform Random Assemble Editing beginning with step 4 on page 60.

#### NOTES:

- Before performing actual Random Assemble Editing, do a few Random Assemble Editing trial runs to check whether the value you have input is appropriate or not, and make adjustments accordingly.
- Depending on the recorder, there may be situations where the timing difference cannot be fully corrected.

Display

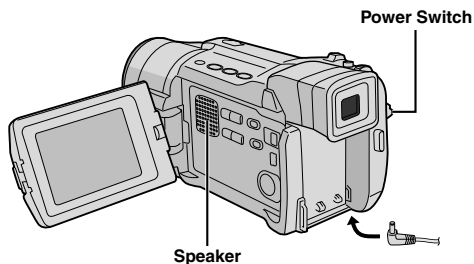
Audio Dub  
Standby mode

Speaker

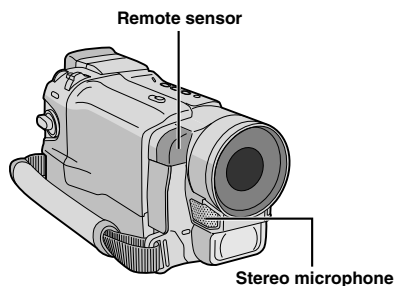

Remote sensor

Stereo microphone

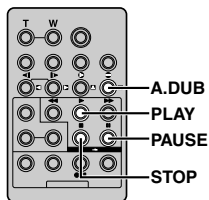

A.DUB

PLAY

PAUSE

STOP

## Audio Dubbing

The audio track can be customized only when recorded in the 12-bit mode (☞ pg. 47).

### NOTES:

- Audio Dubbing is not possible on a tape recorded in 16-bit audio, on a tape recorded in the LP mode or on a blank portion of a tape.
- To perform Audio Dubbing while watching on the television, make connections (☞ pg. 22).

- 1** Play back the tape to locate the point where editing will start, then press **PAUSE** (⏸).
- 2** While holding **A.DUB** (⏮) on the remote control, press **PAUSE** (⏸). "II" appears.
- 3** Press **PLAY** (▶), then begin "narrating". Speak into the microphone.
  - To pause dubbing, press **PAUSE** (⏸).
- 4** To end Audio Dubbing, press **PAUSE** (⏸), then **STOP** (■).

### To hear the dubbed sound during playback . . .

..... set "12BIT MODE" to "SOUND 2" or "MIX" in the Menu Screen (☞ pg. 50, 51).

### NOTES:

- Sound is not heard from the speaker during Audio Dubbing.
- When editing onto a tape that was recorded at 12-bit, the old and new soundtracks are recorded separately.
- If you dub onto a blank space on the tape, the sound may be disrupted. Make sure you only edit recorded areas.
- If feedback or howling occurs during TV playback, move the camcorder's microphone away from the TV, or turn down the TV's volume.
- If you change from 12-bit to 16-bit in mid-recording and then use the tape for Audio Dubbing, it is not effective from the point where 16-bit recording began.
- During Audio Dubbing, when the tape moves to scenes recorded in the LP mode, scenes recorded in 16-bit audio or a blank portion, Audio Dubbing stops (☞ pg. 85).
- To perform Audio Dubbing with a video unit connected to the camcorder's AV connector, first set "S/AV INPUT" to "ON" in the Menu Screen (☞ pg. 50).

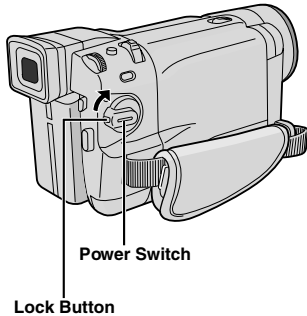

Display



Remote sensor

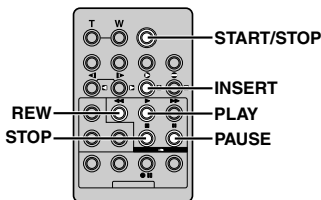
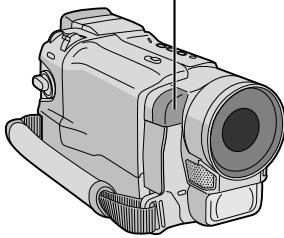

## Insert Editing

You can record a new scene into a previously recorded tape, replacing a section of the original recording with minimal picture distortion at the in and outpoints. The original audio remains unchanged.

### NOTES:

- Before performing the following steps, make sure that "TIME CODE" is set to "ON" in the Menu Screen ( pg. 49, 51).
- Insert Editing is not possible on a tape recorded in the LP mode or on a blank portion of a tape.
- To perform Insert Editing while watching in the television, make connections ( pg. 22).

**1** Play back the tape, locate the Edit-Out point and press **PAUSE (II)**. Confirm the time code at this point ( pg. 49, 51).

**2** Press **REW (◀)** until the Edit-In point is located, then press **PAUSE (II)**.

**3** Press and hold **INSERT (C)** on the remote control, then press **PAUSE (II)**. "IIC" and the Time Code (min.:sec.) appear and the camcorder enters Insert-Pause mode.

**4** Press **START/STOP** to begin editing.

- Confirm the insert at the time code you checked in step 1.
- To pause editing, press **START/STOP**. Press it again to resume editing.

**5** To end Insert Editing, press **START/STOP**, then **STOP (■)**.

### NOTES:

- Program AE with special effects ( pg. 38, 39) can be used to spice up the scenes being edited during Insert Editing.
- During Insert Editing, the date and time information changes.
- If you perform Insert Editing onto a blank space on the tape, the audio and video may be disrupted. Make sure you only edit recorded areas.
- During Insert Editing, when the tape moves to scenes recorded in the LP mode or a blank portion, Insert Editing stops ( pg. 86).



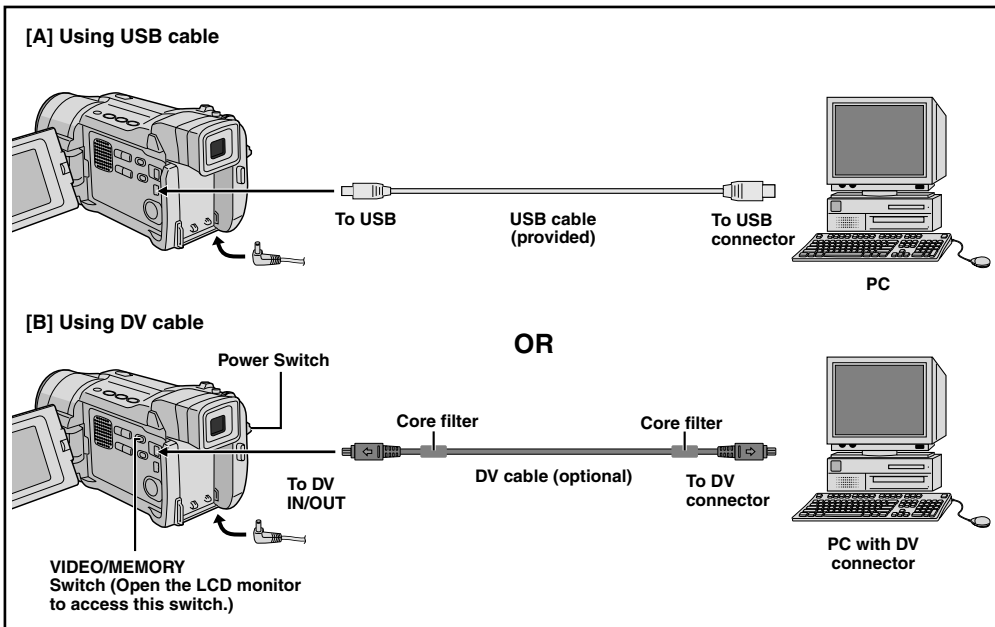

## Connection To A Personal Computer

### [A] Using USB cable

This camcorder can transfer still images to a PC by using the provided software.

### [B] Using DV cable

It is also possible to transfer still images to a PC with a DV connector by using software equipped with the PC or commercially available software.

- 1** Make sure the camcorder and PC are turned off.
- 2** Connect the camcorder to your PC using the appropriate cable as shown in the illustration.
- 3** If you are using the USB connection, set the **VIDEO/MEMORY** switch to "MEMORY".
- 4** Turn the camcorder's Power Switch to "PLAY" while pressing down the Lock Button located on the switch and turn on the PC.
  - Refer to the instruction manual of the software on how to transfer a still image to the PC.
- 5** When finished, turn off the PC first, then the camcorder.

### NOTES:

- Refer to "SOFTWARE INSTALLATION AND USB CONNECTION GUIDE" for the installation of the bundled software and drivers.
- **It is recommended to use the AC Adapter as the power supply instead of the battery pack (pg. 9).**
- **Never connect the USB cable and the DV cable simultaneously to the camcorder. Connect only the cable you wish to use to the camcorder.**
- If the PC connected to the camcorder via the USB cable is not powered, the camcorder does not enter the USB mode.
- The date/time information cannot be captured into the PC.
- Refer to the instruction manuals of the PC and Software.
- The still images can also be transferred to a PC with a DV connector-equipped capture board.
- **When using a DV cable, be sure to use the optional JVC VC-VDV206U or VC-VDV204U DV cable depending on the type of DV connector (4 or 6 pins) on the PC, or use the DV cable provided with the capture board.**
- The system may not work properly depending on the PC or capture board you are using.

"ACCESSING FILES" appears on the LCD monitor while the PC is accessing data in the camcorder or the camcorder is transferring a file to the PC. **NEVER disconnect the USB cable while "ACCESSING FILES" is displayed on the LCD monitor since this can result in product damage.**

VIDEO/MEMORY Switch  
(Open the LCD monitor  
to access this switch.)

Power Switch

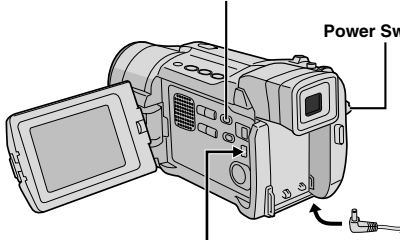

To USB

USB cable  
(provided)

To USB  
connector



USB-equipped PC

Display

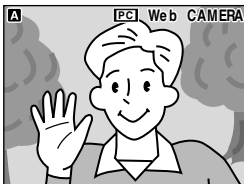

## Using The Camcorder As A WebCam

This camcorder can be used as a WebCam via USB connection.

- 1** Make sure all necessary software (provided) are installed in your PC and all units are turned off.
- 2** Connect the camcorder to your PC using the USB cable.
- 3** Set the **VIDEO/MEMORY** Switch to "MEMORY" and set the Power Switch to "**AUTO**" or "**MANUAL**", then turn on the PC.
  - "Web CAMERA" appears on the screen.
  - If the PC is not powered on, the camcorder does not enter the Web Camera mode.
- 4** When finished, turn off the PC first, then the camcorder. Disconnect the USB cable from the camcorder and PC.

### NOTES:

- It is recommended to use the AC Adapter as the power supply instead of the battery pack (☞ pg. 9).
- Use the provided software PIXELA ImageMixer to capture video in real-time.
- You can also use the camcorder for webconference by using Windows® Microsoft Netmeeting and signing up for Microsoft Hotmail.
- In the Web Camera mode, the following buttons cannot be operated: **E-MAIL**, **SNAPSHOT**, the Recording Start/Stop button.

Refer to the instruction manuals of the PC and provided Software.

**REFERENCES****CONTENTS**

<b>DETAILS</b> .....	68
<b>TROUBLESHOOTING</b> .....	69 – 73
<b>USER MAINTENANCE</b> .....	74
<b>CAUTIONS</b> .....	75 – 77
<b>SPECIFICATIONS</b> .....	78 – 79
<b>INDEX</b> .....	80 – 86
<b>Controls, Connectors And Indicators</b> .....	80 – 81
<b>Indications</b> .....	82 – 86
<b>TERMS</b> .....	87 – <i>Back Cover</i>

ITEMS	NOTES
<p>⇒ <b>Power</b> (☞ pg. 8)</p>	<ul style="list-style-type: none"> <li>○ Perform charging where the temperature is between 10°C and 35°C (50°F and 95°F). 20°C to 25°C (68°F to 77°F) is the ideal temperature range for charging. If the environment is too cold, charging may be incomplete.</li> <li>○ Charging times are for a fully discharged battery pack.</li> <li>○ Charging time varies according to the ambient temperature and the status of the battery pack.</li> <li>○ To avoid interference with reception, do not use the AC Adapter near a radio.</li> <li>○ Since the AC Adapter processes electricity internally, it becomes warm during use. Be sure to use it only in well-ventilated areas.</li> <li>○ The following operation stops charging: <ul style="list-style-type: none"> <li>• Set the Power Switch to "PLAY", "<b>AUTO</b>" or "<b>MANUAL</b>".</li> <li>• Disconnect the AC adapter from the camcorder.</li> <li>• Unplug the AC adapter from the AC outlet.</li> <li>• Detach the battery from the camcorder.</li> </ul> </li> </ul>
<p>⇒ <b>TAPE RECORDING</b> (☞ pg. 16, 17)</p>	<ul style="list-style-type: none"> <li>○ When you use the LCD monitor outdoors in direct sunlight, the LCD monitor may be difficult to see. If this happens, use the viewfinder instead.</li> <li>○ The cassette holder cannot be opened unless a power supply is attached.</li> <li>○ There may be a delay after you open the cassette holder cover until the cassette holder opens. Do not use force.</li> <li>○ Once the cassette holder is closed, it recedes automatically. Wait until it recedes completely before closing the cassette holder cover.</li> <li>○ When the Recording Start/Stop button is pressed, it may take a few seconds before actual recording starts. "⏻" starts rotating when the camcorder actually starts recording.</li> <li>○ The time required to calculate and display the remaining tape length, and the accuracy of the calculation, may vary according to the type of tape used.</li> <li>○ "TAPE END" appears when the tape reaches its end, and the power goes off automatically if left in this condition for 5 minutes. "TAPE END" also appears when a cassette at its end is loaded.</li> </ul>

If, after following the steps in the chart below, the problem still exists, please consult your nearest JVC dealer.

The camcorder is a microcomputer-controlled device. External noise and interference (from a TV, a radio, etc.) might prevent it from functioning properly. In such cases, first disconnect its power supply unit (battery pack, AC Adapter, etc.) and wait a few minutes; and then re-connect it and proceed as usual from the beginning.

SYMPTOM	POSSIBLE CAUSES	CORRECTIVE ACTION
<b>1</b> No power is supplied.	<ul style="list-style-type: none"> <li>• The power is not connected properly.</li> <li>• The battery is dead.</li> </ul>	<ul style="list-style-type: none"> <li>• Connect the AC Adapter securely (☞ pg. 9).</li> <li>• Replace the dead battery with a fully charged one (☞ pg. 8, 9).</li> </ul>
<b>2</b> "SET DATE/TIME!" appears.	<ul style="list-style-type: none"> <li>• The date/time is not set.</li> <li>• The built-in clock battery has run out and the previously set date/time has been erased.</li> </ul>	<ul style="list-style-type: none"> <li>• Set the date/time (☞ pg. 11).</li> <li>• Consult your nearest JVC dealer for replacement.</li> </ul>
<b>3</b> Recording cannot be performed.	<ul style="list-style-type: none"> <li>— For Tape Recording —</li> <li>• The tape's erase protection tab is set to "SAVE".</li> <li>• The Power Switch is set to "PLAY" or "OFF".</li> <li>• The VIDEO/MEMORY Switch is set to "MEMORY".</li> <li>• "TAPE END" appears.</li> <li>• The cassette holder cover is open.</li> <li>— For Memory Card Recording —</li> <li>• The VIDEO/MEMORY Switch is set to "VIDEO".</li> </ul>	<ul style="list-style-type: none"> <li>• Set the tape's erase protection tab to "REC" (☞ pg. 12).</li> <li>• Set the Power Switch to "AUTO" or "MANUAL" (☞ pg. 17).</li> <li>• Set the VIDEO/MEMORY Switch to "VIDEO".</li> <li>• Replace with new cassette (☞ pg. 12).</li> <li>• Close the cassette holder cover.</li> <li>• Set the VIDEO/MEMORY Switch to "MEMORY".</li> </ul>
<b>4</b> There is no picture.	<ul style="list-style-type: none"> <li>• The camcorder is not getting power, or some other malfunction exists.</li> </ul>	<ul style="list-style-type: none"> <li>• Turn the camcorder's power off and on again (☞ pg. 17).</li> </ul>
<b>5</b> The focus does not adjust automatically.	<ul style="list-style-type: none"> <li>• Focus is set to the Manual mode.</li> <li>• The recording was done in a dark place, or the contrast was low.</li> <li>• The lens is dirty or covered with condensation.</li> </ul>	<ul style="list-style-type: none"> <li>• Set Focus to the Auto mode (☞ pg. 43).</li> <li>• Clean the lens and check the focus again (☞ pg. 74).</li> </ul>

SYMPTOM	POSSIBLE CAUSES	CORRECTIVE ACTION
<b>6</b> The cassette will not load properly.	<ul style="list-style-type: none"> <li>• The cassette is in the wrong position.</li> <li>• The battery's charge is low.</li> </ul>	<ul style="list-style-type: none"> <li>• Set it in the right position (☞ pg. 12).</li> <li>• Install a fully charged battery (☞ pg. 8, 9).</li> </ul>
<b>7</b> The memory card will not load properly.	<ul style="list-style-type: none"> <li>• The memory card is in the wrong position.</li> </ul>	<ul style="list-style-type: none"> <li>• Set it in the right position (☞ pg. 14).</li> </ul>
<b>8</b> Snapshot mode cannot be used.	<ul style="list-style-type: none"> <li>• The Squeeze mode is selected.</li> </ul>	<ul style="list-style-type: none"> <li>• Disengage the Squeeze mode (☞ pg. 48).</li> </ul>
<b>9</b> The color of Snapshot looks strange.	<ul style="list-style-type: none"> <li>• The light source or the subject does not include white. Or there are various different light sources behind the subject.</li> <li>• The Sepia or Monotone mode is activated.</li> </ul>	<ul style="list-style-type: none"> <li>• Find a white subject and compose your shot so that it also appears in the frame (☞ pg. 26, 42).</li> <li>• Turn off Sepia and Monotone (☞ pg. 38, 39).</li> </ul>
<b>10</b> The image taken using Snapshot is too dark.	<ul style="list-style-type: none"> <li>• Shooting was performed under backlit conditions.</li> </ul>	<ul style="list-style-type: none"> <li>• Press the <b>BACKLIGHT</b> Button (☞ pg. 44).</li> </ul>
<b>11</b> The image taken using Snapshot is too bright.	<ul style="list-style-type: none"> <li>• The subject is too bright.</li> </ul>	<ul style="list-style-type: none"> <li>• Set "PROGRAM AE" to "SPOTLIGHT" in the Menu Screen (☞ pg. 38).</li> </ul>
<b>12</b> Digital Zoom does not work.	<ul style="list-style-type: none"> <li>• 10X optical zoom is selected.</li> <li>• The <b>VIDEO/MEMORY</b> Switch is set to "MEMORY".</li> </ul>	<ul style="list-style-type: none"> <li>• Set "ZOOM" to "40X" or "700X" in the Menu Screen (☞ pg. 47).</li> <li>• Set the <b>VIDEO/MEMORY</b> Switch to "VIDEO" (☞ pg. 17, 18).</li> </ul>
<b>13</b> The Black & White Fader does not work.	<ul style="list-style-type: none"> <li>• The Sepia or Monotone mode is activated.</li> </ul>	<ul style="list-style-type: none"> <li>• Turn off Sepia and Monotone (☞ pg. 38, 39).</li> </ul>
<b>14</b> Even when Slow Shutter is not selected, the image looks like it is activated.	<ul style="list-style-type: none"> <li>• When shooting in the dark, the unit becomes highly sensitive to light and the image takes on an effect similar to Slow Shutter.</li> </ul>	<ul style="list-style-type: none"> <li>• If you want the lighting to look more natural, set GAIN UP to "AGC" or "OFF" in the Menu Screen (☞ pg. 47).</li> </ul>

SYMPTOM	POSSIBLE CAUSES	CORRECTIVE ACTION
14 Even when Slow Shutter is not selected, the image looks like it is activated.	<ul style="list-style-type: none"> <li>When shooting in the dark, the unit becomes highly sensitive to light and the image takes on an effect similar to Slow Shutter.</li> </ul>	<ul style="list-style-type: none"> <li>If you want the lighting to look more natural, set GAIN UP to "AGC" or "OFF" in the Menu Screen (☞ pg. 47).</li> </ul>
15 White Balance cannot be activated.	<ul style="list-style-type: none"> <li>The Sepia or Monotone mode is activated.</li> </ul>	<ul style="list-style-type: none"> <li>Turn off Sepia or Monotone before setting White Balance (☞ pg. 39, 45).</li> </ul>
16 When shooting a subject illuminated by bright light, vertical lines appear.	<ul style="list-style-type: none"> <li>This is a result of exceedingly high contrast, and is not a malfunction.</li> </ul>	<p style="text-align: center;">_____</p>
17 When the screen is under direct sunlight during shooting, the screen becomes red or black for an instant.	<ul style="list-style-type: none"> <li>This is not a malfunction.</li> </ul>	<p style="text-align: center;">_____</p>
18 During recording, the date/time does not appear.	<ul style="list-style-type: none"> <li>"DATE/TIME" is set to "OFF" in the Menu Screen.</li> </ul>	<ul style="list-style-type: none"> <li>Set "DATE/TIME" to "ON" in the Menu Screen (☞ pg. 49).</li> </ul>
19 Files stored on the memory card cannot be deleted.	<ul style="list-style-type: none"> <li>Files stored on the memory card are protected.</li> </ul>	<ul style="list-style-type: none"> <li>Remove protection from the files stored on the memory card and delete them (☞ pg. 30, 31).</li> </ul>
20 Time code does not appear.	<ul style="list-style-type: none"> <li>"TIME CODE" is set to "OFF" in the Menu Screen.</li> </ul>	<ul style="list-style-type: none"> <li>Set "TIME CODE" to "ON" in the Menu Screen (☞ pg. 49, 50).</li> </ul>
21 Images on the LCD monitor appear dark or whitish.	<ul style="list-style-type: none"> <li>In places subject to low temperature, images become dark due to the characteristics of the LCD monitor. When this happens, the displayed colors differ from those that are actually recorded. This is not a defect of the camcorder.</li> <li>When the LCD monitor's fluorescent light reaches the end of its service life, images on the LCD monitor become dark. Consult your nearest JVC dealer.</li> </ul>	<ul style="list-style-type: none"> <li>Adjust the brightness and angle of the LCD monitor (☞ pg. 16, 17).</li> </ul>

CONTINUED ON NEXT PAGE

SYMPTOM	POSSIBLE CAUSES	CORRECTIVE ACTION
<b>22</b> The rear of the LCD monitor is hot.	<ul style="list-style-type: none"> <li>The light used to illuminate the LCD monitor causes it to become hot.</li> </ul>	<ul style="list-style-type: none"> <li>Close the LCD monitor to turn it off or set the Power Switch to "OFF", and let the unit cool down.</li> </ul>
<b>23</b> The indicators and the image color on the LCD monitor are not clear.	<ul style="list-style-type: none"> <li>This may occur when the surface or the edge of the LCD monitor is pressed.</li> </ul>	_____
<b>24</b> The LCD monitor or viewfinder indications blink.	<ul style="list-style-type: none"> <li>Certain Fade/Wipe effects, certain modes of Program AE with special effects, "DIS" and other functions that cannot be used together are selected at the same time.</li> </ul>	<ul style="list-style-type: none"> <li>Re-read the sections covering Fade/Wipe effects, Program AE with special effects and "DIS" (☞ pg. 38 – 41, 47).</li> </ul>
<b>25</b> Colored bright spots appear all over the LCD monitor or the viewfinder.	<ul style="list-style-type: none"> <li>The LCD monitor and the viewfinder are made with high-precision technology. However, black spots or bright spots of light (red, green or blue) may appear constantly on the LCD monitor or the viewfinder. These spots are not recorded on the tape. This is not due to any defect of the unit. (Effective dots: more than 99.99 %)</li> </ul>	_____
<b>26</b> During recording, sound cannot be heard.	<ul style="list-style-type: none"> <li>This is normal.</li> </ul>	_____
<b>27</b> Play, Rewind and Fast-Forward functions do not work.	<ul style="list-style-type: none"> <li>The Power Switch is set to "AUTO" or "MANUAL".</li> </ul>	<ul style="list-style-type: none"> <li>Set the Power Switch to "PLAY" (☞ pg. 21).</li> </ul>
<b>28</b> A memory card cannot be played back.	<ul style="list-style-type: none"> <li>The Power Switch is set to "AUTO" or "MANUAL".</li> <li>The VIDEO/MEMORY Switch is set to "VIDEO".</li> </ul>	<ul style="list-style-type: none"> <li>Set the Power Switch to "PLAY" (☞ pg. 28).</li> <li>Set the VIDEO/MEMORY Switch to "MEMORY".</li> </ul>
<b>29</b> The LCD monitor image is distorted.	<ul style="list-style-type: none"> <li>During playback of the unrecorded portion, High-speed Search and still playback, LCD monitor indications appear distorted. This is not a defect.</li> </ul>	_____
<b>30</b> Images on the LCD monitor are jittery.	<ul style="list-style-type: none"> <li>The speaker volume is too great.</li> </ul>	<ul style="list-style-type: none"> <li>Turn the speaker volume down (☞ pg. 21).</li> </ul>
<b>31</b> There is no playback picture on the connected TV.	<ul style="list-style-type: none"> <li>Since the analog input mode is engaged, the camcorder is in the Record-Standby mode.</li> </ul>	<ul style="list-style-type: none"> <li>Set "S/AV INPUT" to "OFF" in the Menu Screen (☞ pg. 50).</li> </ul>
<b>32</b> Blocks of noise appear during playback, or there is no playback picture and the screen becomes blue.	_____	<ul style="list-style-type: none"> <li>Clean the video heads with an optional cleaning cassette (☞ pg. 76).</li> </ul>
<b>33</b> The LCD monitor, the viewfinder and the lens have become dirty (ex. fingerprints).	_____	<ul style="list-style-type: none"> <li>Wipe them gently with soft cloth. Wiping strongly can cause damage (☞ pg. 74).</li> </ul>



SYMPTOM	POSSIBLE CAUSES	CORRECTIVE ACTION
34 An unusual mark appears.	—————	<ul style="list-style-type: none"> <li>• Check the section of the manual that explains LCD monitor/viewfinder indications (☞ pg. 82 – 86).</li> </ul>
35 An error indication (E01, E02 or E06) appears.	<ul style="list-style-type: none"> <li>• A malfunction of some kind has occurred. In this case the camcorder's functions become unusable.</li> </ul>	<ul style="list-style-type: none"> <li>• Remove the power supply (battery pack, etc.) and wait a few minutes for the indication to clear. When it does, you can resume using the camcorder. If the indication remains even though you repeat the above two or three times, please consult your nearest JVC dealer. Do not eject the cassette. This will cause damage to the tape.</li> </ul>
36 An error indication (E03 or E04) appears.	<ul style="list-style-type: none"> <li>• A malfunction of some kind has occurred. In this case the camcorder's functions become unusable.</li> </ul>	<ul style="list-style-type: none"> <li>• Eject the cassette once and re-insert it, then check if the indication clears. When it does, you can resume using the camcorder. If the indication remains even though you repeat the above two or three times, please consult your nearest JVC dealer.</li> </ul>
37 The charger indicator on the camcorder does not light.	<ul style="list-style-type: none"> <li>• The temperature of the battery is extremely high/low.</li> <li>• Charging is difficult in places subject to extremely high/low temperatures.</li> </ul>	<ul style="list-style-type: none"> <li>• To protect the battery, it is recommended to charge it in places with a temperature of 10°C to 35°C (50°F to 95°F) (☞ pg. 75).</li> </ul>
38 When the image is printed from the printer, a black bar appears at the bottom of the screen.	<ul style="list-style-type: none"> <li>• This is not a malfunction.</li> </ul>	<ul style="list-style-type: none"> <li>• By recording with "DIS" activated (☞ pg. 47) this can be avoided.</li> </ul>
39 When the camcorder is connected via the DV connector, the camcorder does not operate.	<ul style="list-style-type: none"> <li>• The DV cable was plugged/unplugged with power turned on.</li> </ul>	<ul style="list-style-type: none"> <li>• Turn the camcorder's power off and on again, then operate it.</li> </ul>
40 The memory card cannot be removed from the camcorder.	—————	<ul style="list-style-type: none"> <li>• Push in the memory card a few more times (☞ pg. 14).</li> </ul>

## After Use

- 1** Turn off the camcorder.
- 2** Slide and hold **OPEN/EJECT** in the direction of the arrow, then pull the cassette holder cover open until it locks. The cassette holder opens automatically. Remove the cassette.
- 3** Press "PUSH HERE" to close the cassette holder.
  - Once the cassette holder is closed, it recedes automatically. Wait until it recedes completely before closing the cassette holder cover.
- 4** Tilt the viewfinder upward ①. Press **BATT. RELEASE** ② and remove the battery pack ③.

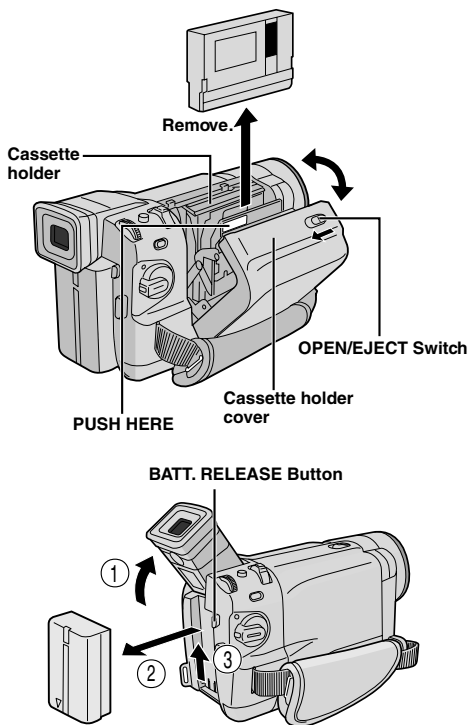

## Cleaning The Camcorder

- 1** To clean the exterior, wipe gently with a soft cloth. Put the cloth in diluted mild soap and wring it well to wipe off heavy dirt. Then wipe again with a dry cloth.
- 2** Press **PUSH OPEN** and open the LCD monitor. Wipe gently with a soft cloth. Be careful not to damage the monitor. Close the LCD monitor.
- 3** To clean the lens, blow it with a blower brush, then wipe gently with lens cleaning paper.
- 4** To clean the viewfinder, raise it to the vertical position. Open the viewfinder cleaning hatch in the direction of the arrow ①.
- 5** Insert a lens blower or soft cloth into the gap at the bottom of the viewfinder and clean the interior of the viewfinder with it ②.
- 6** Close the hatch. Tilt the viewfinder back to the horizontal position.

### NOTES:

- Avoid using strong cleaning agents such as benzine or alcohol.
- Cleaning should be done only after the battery pack has been removed or other power units have been disconnected.
- Mold may form if the lens is left dirty.
- When using a cleaner or chemically treated cloth refer to the cautions of each product.

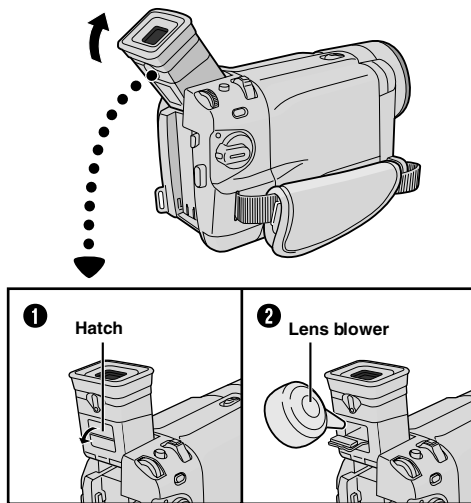

## When using the AC Adapter in areas other than the USA

- The provided AC Adapter features automatic voltage selection in the AC range from 110 V to 240 V.

## USING HOUSEHOLD AC PLUG ADAPTER

In case of connecting the unit's power cord to an AC wall outlet other than American National Standard C73 series type use an AC plug adapter, called a "Siemens Plug", as shown.

For this AC plug adapter, consult your nearest JVC dealer.

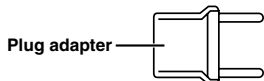

## Video Light

### DANGER

- The video light can become extremely hot. Do not touch it either while in operation or soon after turning it off, otherwise serious injury may result.
- Do not place the camcorder into the carrying case immediately after using the video light, since it remains extremely hot for some time.
- When operating, keep a distance of about 30 cm (11-13/16") between the video light and people or objects.
- Do not use near flammable or explosive materials.
- Do not place the camcorder in a cabinet or box while the video light is in operation.
- When using the video light, if you wish to install the camcorder in a fixed position, attach it to a tripod, etc. Do not affix it directly to a surface such as a table top.
- It is recommended that you consult your nearest JVC dealer for replacing the video light.



## General Battery Precautions

If the remote control is not functioning even if it is being operated correctly, the batteries are exhausted. Replace them with fresh ones.

### Use only the following batteries: AAA (R03) size x 2

Please make note of the following rules for battery use. When misused, the batteries can leak or explode.

1. When replacing batteries, refer to page 54.
2. **Do not** use any different size of batteries from those specified.
3. Be sure to install batteries in the correct direction.
4. **Do not** use rechargeable batteries.
5. **Do not** expose the batteries to excessive heat as they can leak or explode.
6. **Do not** dispose of the batteries in a fire.
7. Remove the batteries from the unit if it is to be stored for an extended period to avoid battery leakage which can cause malfunctions.
8. **Do not** recharge the provided batteries.

## Battery Packs

The supplied battery pack is a lithium-ion battery. Before using the supplied battery pack or an optional battery pack, be sure to read the following cautions:

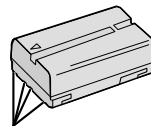

1. **To avoid hazards . . .**
  - ... **do not** burn.
  - ... **do not** short-circuit the terminals. When transporting, make sure the provided battery cap is attached to the battery. If the battery cap is misplaced, carry the battery in a plastic bag.
  - ... **do not** modify or disassemble.
  - ... **do not** expose the battery to temperatures exceeding 60°C (140°F), as this may cause the battery to overheat, explode or catch fire.
  - ... use only specified chargers.
2. **To prevent damage and prolong service life . . .**
  - ... **do not** subject to unnecessary shock.
  - ... charge in an environment where temperatures are within the tolerances shown in the chart below. This is a chemical reaction type battery—cooler temperatures impede chemical reaction, while warmer temperatures can prevent complete charging.
  - ... store in a cool, dry place. Extended exposure to high temperatures will increase natural discharge and shorten service life.
  - ... fully charge and then fully discharge the battery every 6 months when storing the battery pack over a long period time.
  - ... remove from charger or powered unit when not in use, as some machines use current even when switched off.

### NOTES:

- It is normal for the battery pack to be warm after charging, or after use.
- | Temperature Range Specifications |                              |
|----------------------------------|------------------------------|
| Charging .....                   | 10°C to 35°C (50°F to 95°F)  |
| Operation .....                  | 0°C to 40°C (32°F to 104°F)  |
| Storage .....                    | -10°C to 30°C (14°F to 86°F) |
- Recharging time is based on room temperature of 20°C (68°F).
  - The lower the temperature, the longer recharging takes.

## Cassettes

To properly use and store your cassettes, be sure to read the following cautions:

1. **During use . . .**
  - ... make sure the cassette bears the Mini DV mark.
  - ... be aware that recording onto prerecorded tapes automatically erases the previously recorded video and audio signals.
  - ... make sure the cassette is positioned properly when inserting.
  - ... do not load and unload the cassette repeatedly without allowing the tape to run at all. This slackens the tape and can result in damage.
  - ... do not open the front tape cover. This exposes the tape to fingerprints and dust.

**2. Store cassettes . . .**

- ... away from heaters or other heat sources.
- ... out of direct sunlight.
- ... where they won't be subject to unnecessary shock or vibration.
- ... where they won't be exposed to strong magnetic fields (such as those generated by motors, transformers or magnets).
- ... vertically, in their original cases.

### Memory Cards

To properly use and store your memory cards, be sure to read the following cautions:

**1. During use . . .**

- ... make sure the memory card bears the SD or MultiMediaCard mark.
- ... make sure the memory card is positioned properly when inserting.

**2. While the memory card is being accessed (during recording, playback, deletion, initialization, etc.) . . .**

- ... never unload the memory card and never turn off the camcorder.

**3. Store memory cards . . .**

- ... away from heaters or other heat sources.
- ... out of direct sunlight.
- ... where they won't be subject to unnecessary shock or vibration.
- ... where they won't be exposed to strong magnetic fields (such as those generated by motors, transformers or magnets).

### LCD Monitor

**1. To prevent damage to the LCD monitor, DO NOT . . .**

- ... push it strongly or apply any shocks.
- ... place the camcorder with the LCD monitor on the bottom.

**2. To prolong service life . . .**

- ... avoid rubbing it with coarse cloth.

**3. Be aware of the following phenomena for LCD monitor use.****These are not malfunctions:**

- While using the camcorder, the surface around the LCD monitor and/or the back of the LCD monitor may heat up.
- If you leave power on for a long time, the surface around the LCD monitor becomes hot.

### Main Unit

**1. For safety, DO NOT . . .**

- ... open the camcorder's chassis.
- ... disassemble or modify the unit.
- ... short-circuit the terminals of the battery pack. Keep it away from metallic objects when not in use.
- ... allow inflammables, water or metallic objects to enter the unit.
- ... remove the battery pack or disconnect the power supply while the power is on.
- ... leave the battery pack attached when the camcorder is not in use.

**2. Avoid using the unit . . .**

- ... in places subject to excessive humidity or dust.
- ... in places subject to soot or steam such as near a cooking stove.
- ... in places subject to excessive shock or vibration.
- ... near a television set.
- ... near appliances generating strong magnetic or electric fields (speakers, broadcasting antennas, etc.).
- ... in places subject to extremely high (over 40°C or 104°F) or extremely low (under 0°C or 32°F) temperatures.

**3. DO NOT leave the unit . . .**

- ... in places of over 50°C (122°F).
- ... in places where humidity is extremely low (below 35%) or extremely high (above 80%).
- ... in direct sunlight.
- ... in a closed car in summer.
- ... near a heater.

**4. To protect the unit, DO NOT . . .**

- ... allow it to become wet.
- ... drop the unit or strike it against hard objects.
- ... subject it to shock or excessive vibration during transportation.
- ... keep the lens directed at extremely bright objects for long periods.
- ... expose the lens to direct sunlight.
- ... carry it by holding the LCD monitor or the viewfinder.
- ... swing it excessively when using the shoulder strap or the grip.

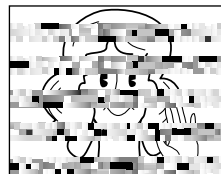
**5. Dirty heads can cause the following problems:**

- No picture during playback.
- Blocks of noise appear during playback.
- During recording or playback, the Head Clog Warning indicator "⊗" appears.
- Recording cannot be performed properly.

In such cases, use an optional cleaning cassette. Insert it and play back. If the cassette is used more than once consecutively, damage to the video heads may result. After the camcorder plays back for about 20 seconds, it stops automatically. Also refer to the cleaning cassette's instructions. If, after using the cleaning cassette, the problems still exist, consult your nearest JVC dealer. Mechanical moving parts used to move the video heads and video tape tend to become dirty and worn out over time. In order to maintain a clear picture at all times, periodic check-ups are recommended after using the unit for about 1,000 hours. For periodic check-ups please consult your nearest JVC dealer.

## How to handle a CD-ROM

- Take care not to soil or scratch the mirror surface (opposite to the printed surface). Do not write anything or put a sticker on either the front or back surface. If the CD-ROM gets dirty, gently wipe it with a soft cloth outward from the center hole using a circular motion.
- Do not use conventional disc cleaners or cleaning spray.
- Do not bend the CD-ROM or touch its mirror surface.
- Do not store your CD-ROM in a dusty, hot or humid environment. Keep it away from direct sunlight.

### About moisture condensation . . .

- You have observed that pouring a cold liquid into a glass will cause drops of water to form on the glass' outer surface. This same phenomenon occurs on the head drum of a camcorder when it is moved from a cool place to a warm place, after heating a cold room, under extremely humid conditions or in a place directly subjected to the cool air from an air conditioner.
- Moisture on the head drum can cause severe damage to the video tape, and can lead to internal damage to the camcorder itself.

### Serious malfunctioning

If malfunctioning occurs, stop using the unit immediately and consult your local JVC dealer.

The camcorder is a microcomputer-controlled device. External noise and interference (from a TV, a radio, etc.) might prevent it from functioning properly. In such cases, first disconnect its power supply unit (battery pack, AC Adapter, etc.) and wait a few minutes and then re-connect it and proceed as usual from the beginning.

### Declaration of Conformity

**Model Number** : GR-DVL920U  
**Trade Name** : JVC  
**Responsible party** : JVC AMERICAS CORP.  
**Address** : 1700 Valley Road Wayne,  
 N. J. 07470  
**Telephone Number** : 973-317-5000

This device complies with Part 15 of FCC Rules. Operation is subject to the following two conditions:

(1) This device may not cause harmful interference, and (2) this device must accept any interference received, including interference that may cause undesired operation.

Change or modifications not approved by the party responsible for compliance could void the user's authority to operate the equipment. This equipment has been tested and found to comply with the limits for a Class B digital device, pursuant to Part 15 of the FCC Rules. These limits are designed to provide reasonable protection against harmful interference in a residential installation. This equipment generates, uses, and can radiate radio frequency energy and, if not installed and used in accordance with the instructions, may cause harmful interference to radio communications. However, there is no guarantee that interference will not occur in a particular installation. If this equipment does cause harmful interference to radio or television reception, which can be determined by turning the equipment off and on, the user is encouraged to try to correct the interference by one or more of the following measures:

Reorient or relocate the receiving antenna.  
 Increase the separation between the equipment and receiver.

Connect the equipment into an outlet on a circuit different from that to which the receiver is connected.

Consult the dealer or an experienced radio/TV technician for help.

This Class B digital apparatus complies with Canadian ICES-003.

Cet appareil numérique de la classe B est conforme à la norme NMB-003 du Canada.

## Camcorder

### General

<b>Power supply</b>	: DC 11.0 V $\overline{\text{---}}$ (Using AC Adapter) DC 7.2 V $\overline{\text{---}}$ (Using battery pack)
<b>Power consumption</b>	
<b>LCD monitor off, viewfinder on</b>	: Approx. 4.5 W
<b>LCD monitor on, viewfinder off</b>	: Approx. 5.7 W
<b>Video light</b>	: Approx. 2.8 W
<b>Dimensions (W x H x D)</b>	: 79 mm x 89 mm x 184 mm (3-1/8" x 3-9/16" x 7-1/4") (with the LCD monitor closed and the viewfinder pushed down)
<b>Weight</b>	: Approx. 580 g (1.3 lbs)
<b>Operating temperature</b>	: 0°C to 40°C (32°F to 104°F)
<b>Operating humidity</b>	: 35% to 80%
<b>Storage temperature</b>	: -20°C to 50°C (-4°F to 122°F)
<b>Pickup</b>	: 1/3.8" CCD
<b>Lens</b>	: F 1.8, f = 3.8 mm to 38 mm, 10:1 power zoom lens
<b>Filter diameter</b>	: $\varnothing$ 37 mm
<b>LCD monitor</b>	: 3.5" diagonally measured, LCD panel/TFT active matrix system
<b>Viewfinder</b>	: Electronic viewfinder with 0.44" color LCD
<b>Speaker</b>	: Monaural

### Digital Video Camera

<b>Format</b>	: DV format (SD mode)
<b>Signal format</b>	: NTSC standard
<b>Recording/Playback format</b>	: Video: Digital component recording Audio: PCM digital recording, 32 kHz 4-channel (12-bit), 48 kHz 2-channel (16-bit)
<b>Cassette</b>	: Mini DV cassette
<b>Tape speed</b>	: SP: 18.8 mm/s LP: 12.5 mm/s
<b>Maximum recording time (using 80 min. cassette)</b>	: SP: 80 min. LP: 120 min.

## Digital Still Camera Function

<b>Storage media</b>	: SD Memory Card/MultiMediaCard
<b>Compression system</b>	: Still image : JPEG (compatible) Moving image : MPEG4 (compatible)
<b>File size</b>	: 3 modes (1280 x 960 pixels, 1024 x 768 pixels, 640 x 480 pixels)
<b>Picture quality</b>	: 2 modes (FINE/STANDARD)
<b>Approximate number of storable images</b>	:  pg. 27.

## Connectors

### S-Video

<b>Output</b>	: Y : 1 V (p-p), 75 Ω, analog C : 0.29 V (p-p), 75 Ω, analog
<b>Input</b>	: Y : 0.8 V (p-p) – 1.2 V (p-p), 75 Ω, analog C : 0.2 V (p-p) – 0.4 V (p-p), 75 Ω, analog

### AV

<b>Video output</b>	: 1 V (p-p), 75 Ω, analog
<b>Video input</b>	: 0.8 V (p-p) – 1.2 V (p-p), 75 Ω, analog
<b>Audio output</b>	: 300 mV (rms), 1 kΩ, analog, stereo
<b>Audio input</b>	: 300 mV (rms), 50 kΩ, analog, stereo

### DV

<b>Output</b>	: 4-pin, IEEE 1394 compliant
<b>Input</b>	: 4-pin, IEEE 1394 compliant

### USB

<b>EDIT</b>	: ø3.5 mm, 2-pole
-------------	-------------------

## AC Adapter

### Power requirement

<b>U.S.A. and Canada</b>	: AC 120 V $\sim$ , 60 Hz
<b>Other countries</b>	: AC 110 V to 240 V $\sim$ , 50 Hz/60 Hz
<b>Output</b>	: DC 11 V $\overline{\text{---}}$ , 1 A

Specifications shown are for SP mode unless otherwise indicated. E & O.E. Design and specifications subject to change without notice.

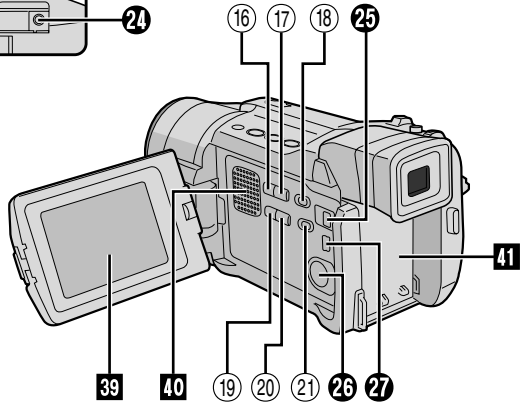
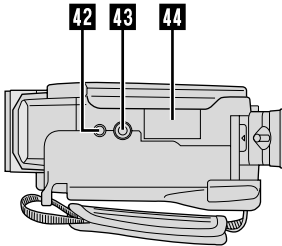
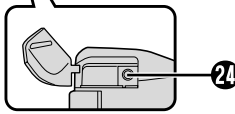
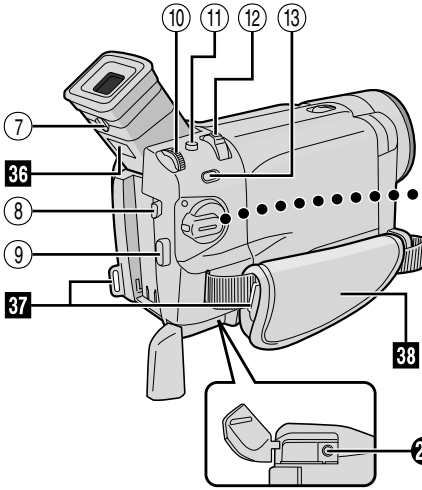
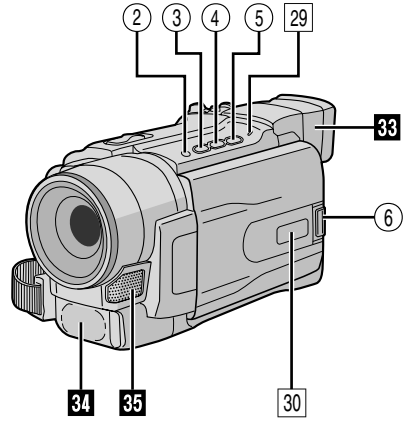
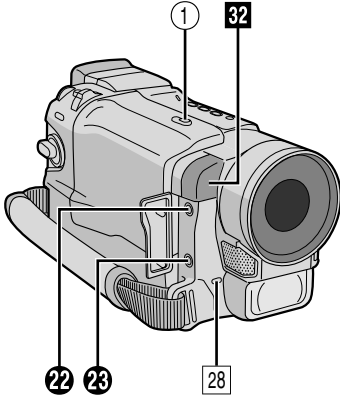



## Controls

- ① OPEN/EJECT Switch ..... pg. 12
- ② • Stop Button [■] ..... pg. 21
- BACKLIGHT Button ..... pg. 44
- ③ • Rewind Button [◀◀] ..... pg. 21
- NIGHT Button ..... pg. 38
- ④ Play/Pause Button [▶/⏸] ..... pg. 21
- ⑤ Fast-Forward Button [▶▶] ..... pg. 21
- ⑥ Monitor Open Button [PUSH OPEN] ..... pg. 16
- ⑦ Diopter Adjustment Control ..... pg. 10
- ⑧ Battery Release Button  
[BATT. RELEASE] ..... pg. 8
- ⑨ Recording Start/Stop Button ..... pg. 16
- ⑩ • MENU Wheel [+ , - , PUSH] ..... pg. 46
- LCD Monitor BRIGHT (Brightness)  
Control [+ , -] ..... pg. 16
- ⑪ Snapshot Button  
[SNAPSHOT] ..... pg. 26, 27, 32, 42
- ⑫ • Power Zoom Lever [T/W] ..... pg. 18
- Speaker Volume Control [VOL.] ..... pg. 21
- ⑬ • FOCUS Button ..... pg. 43
- BLANK Button ..... pg. 24
- ⑭ Lock Button ..... pg. 17
- ⑮ Power Switch  
[ **AUTO** , **MANUAL** , PLAY , OFF ] ..... pg. 17
- ⑯ INDEX Button ..... pg. 29
- ⑰ INFO Button ..... pg. 29
- ⑱ VIDEO/MEMORY Switch  
[VIDEO , MEMORY] ..... pg. 17
- ⑲ E-MAIL Button ..... pg. 33
- ⑳ SELECT Button ..... pg. 28
- ㉑ Video Light Switch  
[LIGHT OFF/AUTO/ON] ..... pg. 19

## Connectors

The connectors ㉒ to ㉔ are located beneath a cover.

- ㉒ Audio/Video Input/Output Connector  
[AV] ..... pg. 22, 52, 59
- ㉓ Edit Connector [EDIT] ..... pg. 59

- ㉔ DC Input Connector ..... pg. 8, 9
- ㉕ Digital Video Connector  
[DV IN/OUT] (i.Link\*) ..... pg. 53, 65
- \* i.Link refers to the IEEE1394-1995 industry specification and extensions thereof. The  logo is used for products compliant with the i.Link standard.
- ㉖ S-Video Input/Output Connector  
[S-VIDEO] ..... pg. 22, 52, 59
- ㉗ USB (Universal Serial Bus)  
Connector ..... pg. 65, 66

## Indicators

- ㉘ Tally Lamp ..... pg. 16, 48
- ㉙ CHARGE Lamp ..... pg. 8
- ㉚ Side LED Indicator ..... pg. 49
- ㉛ Power Lamp ..... pg. 16, 17

## Other Parts

- ㉜ • Remote Sensor ..... pg. 54
- Camera Sensor
- Be careful not to cover this area, a sensor necessary for shooting is built-in here.
- ㉝ Viewfinder ..... pg. 10
- ㉞ Video Light ..... pg. 19
- ㉟ Stereo Microphone ..... pg. 63
- ㊱ Viewfinder Cleaning Hatch ..... pg. 74
- ㊲ Shoulder Strap Eyelets ..... pg. 10
- ㊳ Grip Strap ..... pg. 10
- ㊴ LCD Monitor ..... pg. 16, 17
- ㊵ Speaker ..... pg. 21
- ㊶ Battery Pack Mount ..... pg. 8
- ㊷ Stud Hole ..... pg. 10
- ㊸ Tripod Mounting Socket ..... pg. 10
- ㊹ MEMORY CARD Cover ..... pg. 14

## LCD Monitor/Viewfinder Indications During Tape Recording Only

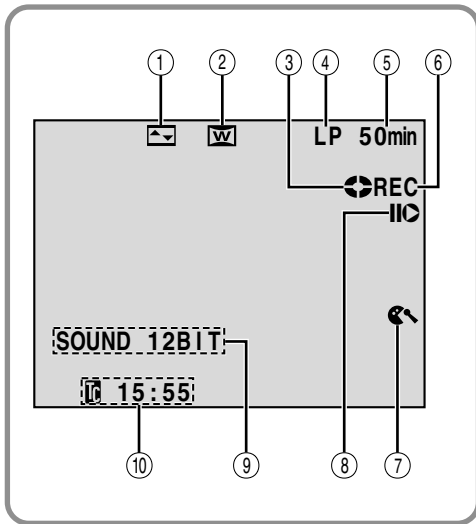

- ① Displays the selected Fade/Wipe effect. (☞ pg. 40, 41)
- ② Appears when in the Squeeze or Cinema mode. (☞ pg. 48)
- ③ Rotates while the tape is running. (☞ pg. 16)
- ④ Displays the recording mode (SP or LP). (☞ pg. 13)
- ⑤ Displays the tape remaining time. (☞ pg. 16)
- ⑥
  - “REC” appears during recording.
  - “PAUSE” appears during Record-Standby mode. (☞ pg. 16)
- ⑦ Appears when the wind cut mode is engaged to cut down on noise created by wind. (☞ pg. 48)
- ⑧ Appears when the Insert Editing (I) or Insert Editing Pause (II C) mode is engaged. (☞ pg. 64)
- ⑨ Displays the sound mode for approx. 5 seconds after turning on the camcorder. (☞ pg. 47)
- ⑩ Displays the Time Code. (☞ pg. 20, 49)



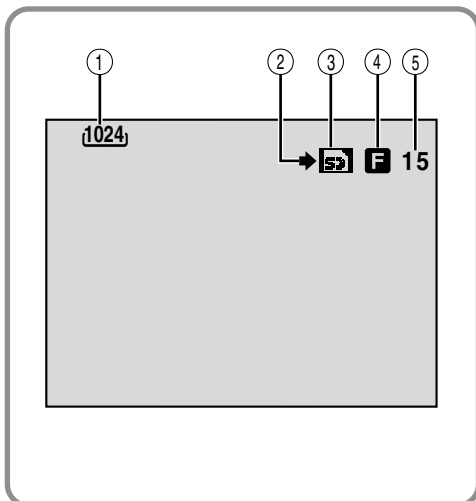

## LCD Monitor/Viewfinder Indications During Memory Card Recording Only

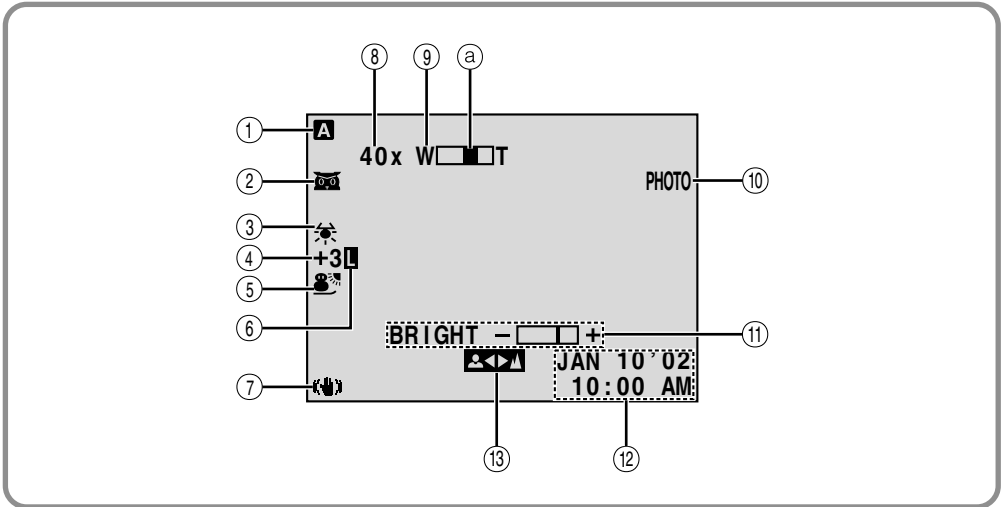

- ① Displays the image size. (☞ pg. 14)
- ② Appears and blinks during shooting. (☞ pg. 26)
- ③
  - Appears during shooting.
  - Blinks when a memory card is not loaded. (☞ pg. 26)
- ④ Displays the picture quality. There are 2 modes available: F (Fine) and S (Standard) (in order of quality). (☞ pg. 14)
- ⑤ Displays the remaining number of shots that can be stored. (☞ pg. 26)

## LCD Monitor/Viewfinder Indications During Both Tape And Memory Card Recording



- ① Appears when the Power Switch is set to "AUTO". (☞ pg. 17)
- ② •  : Appears when Night-Alive is engaged. (☞ pg. 38)
-  : Appears when "GAIN UP" is set to "AUTO" and the shutter speed is being automatically adjusted. (☞ pg. 47)
- ③ Appears when the white balance is adjusted. (☞ pg. 45)
- ④ • "+3" : Appears when the exposure is adjusted. (☞ pg. 44)
-  : Appears when backlight compensation is used. (☞ pg. 44)
- ⑤ Displays the selected Program AE with special effects. (☞ pg. 38)
- ⑥ Appears when the iris is locked. (☞ pg. 44)
- ⑦ Appears when Digital Image Stabilizer ("DIS") is engaged. (☞ pg. 47)
- ⑧ Approximate zoom ratio: Appears during zooming. (☞ pg. 18)
- ⑨ Appears during zooming.
-  : Zoom level indicator (☞ pg. 18)
- ⑩ Appears when taking a Snapshot. (☞ pg. 26, 42)
- ⑪ Displays the brightness of the LCD monitor. (☞ pg. 16)
- ⑫ Displays the date/time. (☞ pg. 11)
- ⑬ Appears when the focus is adjusted manually. (☞ pg. 43)

## LCD Monitor/Viewfinder Indications During Tape Playback

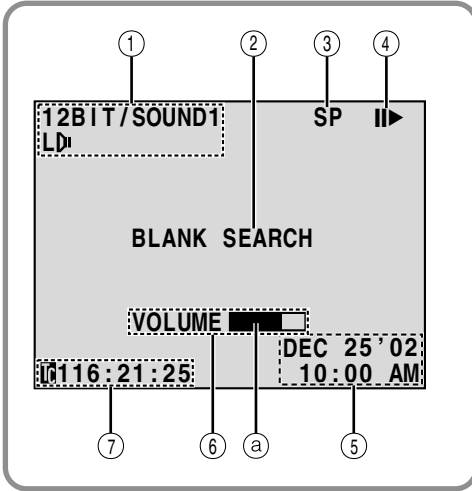





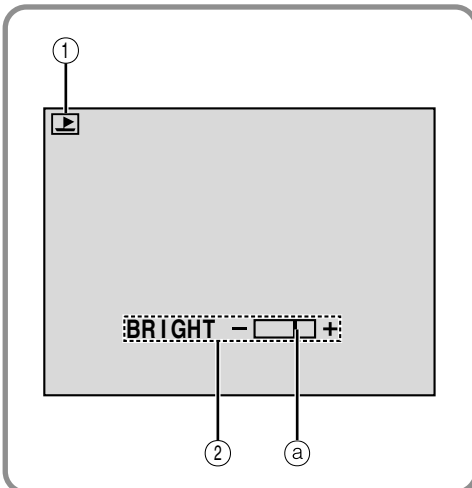

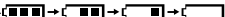

- ① Displays the sound mode. (☞ pg. 50, 51)
- ② Displays the Blank Search mode. (☞ pg. 24)
- ③ Displays the tape speed. (☞ pg. 13)
- ④ Appears while a tape is running.
  - ▶ : Playback
  - ▶▶ : Fast-Forward/Shuttle search
  - ◀◀ : Rewind/Shuttle search
  - || : Pause
  - ||▶ : Forward slow-motion
  - ◀|| : Reverse slow-motion
  - ◐ : Audio Dubbing
  - ||◐ : Audio Dubbing Pause
- ⑤ Displays the date/time. (☞ pg. 50, 51)
- ⑥ • BRIGHT : Displays the brightness of the LCD monitor. (☞ pg. 16)
- VOLUME : Displays the speaker volume. (☞ pg. 21)
- ⓐ The level indicator moves.
- ⑦ Displays the time code. (☞ pg. 50, 51)

## LCD Monitor/Viewfinder Indications During Memory Card Playback









- ① Displays the operation mode. (☞ pg. 29)
- ② Displays the brightness of the LCD monitor. (☞ pg. 16)
- ⓐ The level indicator moves.

## Warning Indications







Indications	Function
	<p>Displays the battery remaining power.</p> <p>Remaining power level: high  →  →  → </p> <p>Remaining power level: exhausted </p> <p>As the battery power comes close to nil, the battery indicator  blinks. When the battery power is exhausted, power turns off automatically.</p>
	<p>Appears when no tape is loaded. (☞ pg. 12)</p>
<p>CHECK TAPE'S ERASE PROTECTION TAB</p>	<p>Appears when the erase protection tab is set to "SAVE" while the Power Switch is set to "AUTO" or "MANUAL" and the VIDEO/MEMORY Switch is set to "VIDEO". (☞ pg. 12)</p>
<p> HEAD CLEANING REQUIRED USE CLEANING CASSETTE</p>	<p>Appears if dirt is detected on the heads during recording or playback. Use an optional cleaning cassette. (☞ pg. 76)</p>
<p> CONDENSATION OPERATION PAUSED PLEASE WAIT</p>	<p>Appears if condensation occurs. When this indication is displayed, wait more than 1 hour until condensation disappears.</p>
<p>TAPE!</p>	<p>Appears if a tape is not loaded when the Recording Start/Stop Button or SNAPSHOT Button is pressed while the Power Switch is set to "AUTO" or "MANUAL" and the VIDEO/MEMORY Switch is set to "VIDEO".</p>
<p>TAPE END</p>	<p>Appears when the tape ends during recording or playback. (☞ pg. 68)</p>
<p>DIFFERENT FORMATTED TAPE</p>	<p>Appears if a tape in another format is loaded when the VIDEO/MEMORY Switch is set to "VIDEO".</p>
<p>SET DATE/TIME!</p>	<ul style="list-style-type: none"> <li>● Appears when the date/time is not set. (☞ pg. 11)</li> <li>● Appears when the built-in clock battery runs out and the previously set date/time is erased. Consult your nearest JVC dealer for replacement.</li> </ul>
<p>LENS CAP</p>	<p>Appears for 5 seconds after power is turned on if the lens cap is attached.</p>
<p>A. DUB ERROR!</p>	<p>Appears if Audio Dubbing is attempted on a blank portion of a tape. (☞ pg. 63)</p>
<p>A. DUB ERROR! &lt;CANNOT DUB ON A LP RECORDED TAPE&gt; &lt;CANNOT DUB ON A 16BIT RECORDING&gt; &lt;CHECK TAPE'S ERASE PROTECTION TAB&gt;</p>	<ul style="list-style-type: none"> <li>● Appears if Audio Dubbing is attempted on a tape recorded in the LP mode. (☞ pg. 63)</li> <li>● Appears if Audio Dubbing is attempted on a tape recorded in 16-bit audio. (☞ pg. 63)</li> <li>● Appears if A. DUB (⊖) on the remote control is pressed when the erase protection tab is set to "SAVE". (☞ pg. 63)</li> </ul>

Indications	Function
INSERT ERROR!	Appears if Insert Editing is attempted on a blank portion of a tape. (☞ pg. 64)
INSERT ERROR! <CANNOT EDIT ON A LP RECORDED TAPE> <CHECK TAPE'S ERASE PROTECTION TAB>	<ul style="list-style-type: none"> <li>● Appears if Insert Editing is attempted on a tape recorded in the LP mode. (☞ pg. 64)</li> <li>● Appears if INSERT (C) on the remote control is pressed when the erase protection tab is set to "SAVE". (☞ pg. 64)</li> </ul>
MEMORY IS FULL	Appears when the memory card's memory is full and shooting is not possible.
COPYING FAILED	<ul style="list-style-type: none"> <li>● Appears if dubbing of copyguarded signals is attempted while this camcorder is being used as a recorder.</li> <li>● Appears in the following cases when dubbing from a tape to a memory card:               <ul style="list-style-type: none"> <li>– when no memory card is loaded.</li> <li>– when the memory card's memory is full.</li> <li>– when the memory card is not formatted.</li> </ul> </li> </ul> (☞ pg. 32)
MEMORY CARD! or PLEASE INSERT CARD	Appears if there is no memory card loaded when you attempt to record on a memory card or access data on a memory card.
PLEASE FORMAT	Appears when there is a problem with a memory card and its memory is corrupt, or it has not been initialized. Initialize the memory card. (☞ pg. 36)
NO IMAGES STORED	Appears if there are no image files stored on the memory card when you attempt memory card playback.
NO E-MAIL CLIP STORED	Appears if there are no E-Mail Clip files stored on the memory card when you attempt memory card playback. (☞ pg. 33)
CARD ERROR!	Appears when the camcorder does not recognize the loaded memory card. Remove the memory card once and insert it again. Repeat these procedures until no indication appears. If the indication still appears, the memory card is corrupted.
UNSUPPORTED FILES	Appears if a file in another format is selected.
CHECK CARD'S WRITE PROTECTION SWITCH	<ul style="list-style-type: none"> <li>● Appears when you attempt to record on a copy-protected SD Memory Card.</li> <li>● Appears when you attempt Memory Card menu operation with a copy-protected SD Memory Card loaded.</li> </ul>
E01, E02 or E06 UNIT IN SAFEGUARD MODE REMOVE AND REATTACH BATTERY	The error indications (E01, E02 or E06) show what type of malfunction has occurred. When an error indication appears, the camcorder turns off automatically. Remove the power supply (battery, etc.) and wait a few minutes for the indication to clear. When it does, you can resume using the camcorder. If the indication remains, consult your nearest JVC dealer.
E03 or E04 UNIT IN SAFEGUARD MODE EJECT AND REINSERT TAPE	The error indications (E03 or E04) show what type of malfunction has occurred. When an error indication appears, the camcorder turns off automatically. Eject the cassette once and re-insert it, then check if the indication clears. When it does, you can resume using the camcorder. If the indication remains, consult your nearest JVC dealer.







**A**

- AC Adapter .....  pg. 8, 9
- Analog Input .....  pg. 50, 52
- Audio Dubbing .....  pg. 63
- Auto Date .....  pg. 49
- Auto Focus .....  pg. 43
- Auto Playback .....  pg. 28
- Auto Shut off .....  pg. 16, 21, 27











**B**

- Backlight Compensation .....  pg. 44
- Battery Low .....  pg. 85
- Battery Pack .....  pg. 8, 9, 75
- Beep .....  pg. 48
- Blank Search .....  pg. 24
- Brighten The LCD Monitor .....  pg. 16



**C**

- Channels (Left/Right) .....  pg. 51
- Charge The Battery Pack .....  pg. 8
- Cinema .....  pg. 48
- Classic Film .....  pg. 39
- Classic Film .....  pg. 39
- Clean The Camcorder .....  pg. 74
- Connections .....  pg. 8, 9, 22, 23, 52, 59, 66, 67



**D**

- Darken The LCD Monitor .....  pg. 16
- Date/Time Display .....  pg. 49 – 51
- Date/Time Settings .....  pg. 11
- Deleting Files .....  pg. 31
- Demonstration Mode .....  pg. 6, 49
- Digital Zoom .....  pg. 18, 47
- DIS (Digital Image Stabilizer) .....  pg. 47
- Diopter Adjustment .....  pg. 10
- DPOF (Digital Print Order Format) .....  pg. 34
- Dubbing .....  pg. 52, 53

**E**

- E-Mail Clip Recording .....  pg. 33
- Erase Protection .....  pg. 12
- Exposure Control .....  pg. 44







**F**

- Fade-In/Out .....  pg. 40, 41
- Fast-Forward The Tape .....  pg. 21
- Frame-By-Frame Playback .....  pg. 21, 56

**G**

- Gain Up .....  pg. 47
- Grip Adjustment .....  pg. 10



**I**

- Icons .....  pg. 47 – 49
- Index Playback .....  pg. 29
- Index Screen .....  pg. 29
- Initialize A Memory Card .....  pg. 36
- Insert Editing .....  pg. 64
- Iris .....  pg. 44
- Iris Lock .....  pg. 44











**J**

- Journalistic Shooting .....  pg. 17

**L**

- LCD monitor/Viewfinder Indications ....  pg. 82 – 86
- Load A Tape .....  pg. 12







**M**

- Manual Focus .....  pg. 43
- Memory Card .....  pg. 14, 76
- Menu Screen, CAMERA .....  pg. 47
- Menu Screen, DISPLAY .....  pg. 49, 50
- Menu Screen, DSC .....  pg. 14, 49
- Menu Screen, MANUAL .....  pg. 47, 48
- Menu Screen, SYSTEM .....  pg. 48 – 50
- Menu Screen, VIDEO .....  pg. 50
- Monotone .....  pg. 39
- Motor Drive Mode .....  pg. 42
- MultiMediaCard .....  pg. 14, 76







**N**

- Night-Alive .....  pg. 38

**P**

- Picture Quality/Image Size .....  pg. 14
- Playback Special Effects .....  pg. 56
- Playback Zoom .....  pg. 57
- Power Switch Position .....  pg. 17
- Program AE With Special Effects .....  pg. 38, 39
- Protecting Files .....  pg. 30
- Provided Accessories .....  pg. 5

**R**

- Random Assemble Editing .....  pg. 58 – 62
- Record-Standby .....  pg. 16
- Recording Mode .....  pg. 13
- Remote Control .....  pg. 54
- Reset .....  pg. 49
- Rewind The Tape .....  pg. 21

**S**

SD Memory Card .....	pg. 14, 76
Self-Recording .....	pg. 17
Sepia .....	pg. 39
Set Remote Control/VCR Code .....	pg. 58
Shuttle Search .....	pg. 21
Shutter Speed .....	pg. 39
Slow-Motion Playback .....	pg. 21, 56
Slow Shutter .....	pg. 39
Snapshot .....	pg. 26, 42
Snapshot Mode .....	pg. 42
Snow .....	pg. 39
Sound Mode .....	pg. 47, 50, 51
Speaker Volume .....	pg. 21
Specifications .....	pg. 78, 79
Sports .....	pg. 39
Spotlight .....	pg. 39
Squeeze .....	pg. 48
Still Playback .....	pg. 21
Strobe .....	pg. 39

**T**

Tally .....	pg. 48
Tele Macro .....	pg. 48
Time Code .....	pg. 20, 49 – 51
Tripod Mounting .....	pg. 10
Twilight .....	pg. 39

**U**

Unload A Tape .....	pg. 12
---------------------	--------

**V**

VIDEO/MEMORY Switch Position .....	pg. 17
Video Light .....	pg. 19

**W**

WebCam .....	pg. 66
White Balance .....	pg. 45
Wide Mode .....	pg. 48
Wind Cut .....	pg. 48
Wipe In/Out .....	pg. 40, 41

**Z**

Zooming .....	pg. 18
---------------	--------

**See previous page as well.**

# JVC

VICTOR COMPANY OF JAPAN, LIMITED